

Kwikkee[®] PRODUCTS

by  Lippert Components[®]

KWIKEE[®] REVOLUTION STEP SERIES OWNER'S MANUAL (3010002262)

TABLE OF CONTENTS

Safety Information	2
Product Information	2
General Service Notes	3
Prior To Operation	3
Operation	4
Step With Control Unit	4
Troubleshooting	5
Step Test Procedure	5
Testing The Motor	7
Disconnect The 2-Way Connector Between The Step Motor And The Control Unit	7
Testing The 4-Way Connector	7
Maintenance	9
Step Motor Assembly Lubrication	9
Maintenance In A Salt Environment	9

Safety Information

WARNING

The “WARNING” symbol above is a sign that an installation procedure has a safety risk involved and may cause death or serious injury if not performed safely and within the parameters set forth in this manual.

Always wear eye protection when performing this installation procedure. Other safety equipment to consider would be hearing protection, gloves, and possibly a full face shield, depending on the nature of the installation procedure.

WARNING

The coach **MUST** be supported per manufacturer's specifications before working underneath. Failure to do so may result in death or serious injury.

WARNING

Failure to act in accordance with the following may result in death or serious personal injury. Read all operating instructions first before using your Kwikiee Electric Step.

CAUTION

Moving parts can pinch, crush or cut. Keep clear and use caution.

Product Information

NOTE: This information was obtained from Kwikiee manual 3010002262 Rev 0A dated September 2009. This manual does not apply and should not be used as a reference to previous versions of the Kwikiee electric step.

This manual has been provided to assist you with the operation, maintenance, and troubleshooting of the Kwikiee Electric Step equipped for use with a step lockout switch, control unit and permanent magnet motor. The control unit is essentially a current sensor as well as a switching device. When the motor assembly moves the step tread to its extended position, or stops moving because of an obstruction such as a curb or the binding of a damaged or bent step frame, the motor draws a higher amount of current. The control unit ‘senses’ the higher current draw and shuts off the power to the motor.

All control units are equipped with an ignition override system. This system is designed so that the vehicle will not be driven with the step in the extended position. When the step is locked in the extended position (step lockout switch is in the 'off' position), the door closed, and the ignition is turned on, the ignition override system will engage and the step will automatically retract.

The 'Auto Extend' feature is designed to extend the step when the door is opened for the first time after the vehicle ignition is turned off, even if the step override switch is turned off. When the ignition is switched on, the function of the step override switch is disabled and the step will always extend when the door is opened and retract when the door is closed.

General Service Notes

WARNING

12 volt automotive batteries contain sulfuric acid which can cause severe burns. Avoid contact with the skin, eyes and clothing. 12 volt automotive batteries produce hydrogen gas which is explosive; keep cigarettes, open flames and sparks away from the battery at all times.

CAUTION

Keep fingers, arms, and legs clear of step mechanism while performing these tests.

If the power wire to the step is disconnected from its source and reconnected, a spark is common. This is caused by the momentary charging of the control unit and does not necessarily indicate the system is staying on, which would cause a drain on the battery. If battery drain is suspected, observe the under step light (if so equipped) while the step is extending. The override switch **MUST** be 'off' for the under step light to operate.

Prior To Operation

Be sure that all ground connections are securely fastened with good metal-to-metal contact. A good ground is required for proper step operation. To determine if a control unit is not shutting off:

1. Remove the 4-way connector to the chassis and the 2-way connector between the step motor and the control unit.
2. Place a voltmeter between the red and yellow motor wires at the 2-way connector from the control unit. Reconnect the 4-way connector.
3. Turn the override switch 'on.' If any voltage registers on the voltmeter for more than five seconds, the control unit is not shutting off and may be defective.

NOTE: When doing this test, switch the voltmeter leads back and forth between the red and yellow motor wires to be sure no voltage registers.

4. If any voltage does register, disconnect the 4-way connector to keep the step motor from overheating.
5. If 0 voltage is present, the control unit has shut off and is normal.

If the step assembly does not work or operates erratically, such as extending only part way and then shutting off, the first item that should be checked is the vehicle's battery. Low supply voltage may cause erratic operation of the step. Poor ground connections may also cause erratic operation of the step assembly. Check battery voltage and condition. A battery in good condition that is properly charged, will have a voltage reading of approximately 12.6 volts with no load. Check the voltage at the battery and then also at the 4-way connector located on the control unit. Insure that all battery and step control unit connections are clean and secured. Recharge or replace the battery as necessary, and then retest the step for proper operation.

The step assembly may also operate erratically if the step is being operated directly from a converter, where the output from the converter is not adequate or properly filtered for a clean DC voltage. The converter **MUST** be capable of producing a minimum of 30 amps for proper step assembly operation.

If the ground to the control unit is lost, either between the step control unit and the vehicle chassis (the long green ground wire) or between the vehicle battery and the ground (negative battery cable) the step will not function. Make sure the battery terminals and all wire connections are clean and tight. Verify that all wires meet the minimum requirements.

Operation

WARNING

If the vehicle is driven with the step in the extended position, there is the possibility of causing major damage to both the step and the coach.

WARNING

Step control wiring is only to be used for step and step light (provided with the step) functions. Do not splice, cut or tap into any of the step wiring. Failure to heed this warning may result in voiding of the warranty, and/or failure of the step control, which may result in the loss of step function or fire in the step control.

Step With Control Unit

1. After the installation is complete and with the entrance door open, turn the override switch to the 'OFF' position.

NOTE: Some steps are not equipped with an override switch. They are activated only with a door switch.

2. Close the door. The step should retract and lock in the 'up' position.
3. Open the door. The step should extend and lock in the 'down' position with the under step light illuminated.

NOTE: The under step light operation is as follows:

- A. The light is 'on' when the step is extended
- B. The light is 'off' when the step is retracted
- C. In the event the coach door/screen door is left open, the light will turn 'off' after five minutes.

4. If your step is equipped with an override switch, turn it to the 'ON' position. The step should remain in the extended position with the under step light 'OFF' when the door is closed.
5. With the step override switch turned 'ON', the step extended, and the entrance door closed, turn the vehicle ignition on. The ignition override system will go into effect and steps automatically retract.

NOTE: If the yellow wire from the 4-way connector is not connected to an ignition power source, the ignition safety system will be inoperative and the step will remain in the extended position. In this case, the override switch **MUST** be turned 'off' for the step to retract.

6. Turn the vehicle ignition off and open the door. The step will extend and lock in the 'down' position. This is the 'Auto Extend' feature. When the vehicle ignition is turned on, the step will activate with the door movement, regardless of the step override switch position.

NOTE: If the yellow wire from the 4-way connector is not connected to an ignition power source, the ignition will not cause the step to retract if the step override switch is on, regardless of the door position.

Troubleshooting

⚠️ WARNING

12 volt automotive batteries contain sulfuric acid which can cause severe burns. Avoid contact with the skin, eyes and clothing. 12 volt automotive batteries produce hydrogen gas which is explosive; keep cigarettes, open flames and sparks away from the battery at all times.

⚠️ CAUTION

Keep fingers, arms, and legs clear of step mechanism while performing these tests. Do not allow the battery terminals to come in contact with the step.

The following Step Test Procedures have been provided to troubleshoot and test all of the KwikEE Automatic Electric Step functions. They are designed to initially check the step's basic functions separately from the RV wiring to determine whether or not the step is malfunctioning. The following procedures test the various components of the step until the source of the malfunction is located. Using these procedures will shorten and reduce the time spent troubleshooting.

Some portions of the test procedures require additional equipment. This equipment includes: a voltmeter, a well charged 12 volts DC automotive battery, and a 4-way connector/pigtail Part Number 909306000 (KwikEE) or Part Number 369243 (LCI).

If you need assistance, contact Lippert Components, Inc. Customer Service at 1-574-537-8900.

Step Test Procedure

1. Inspect the step for visible damage that might restrict the step operation.
2. Obtain a 4-way pigtail connector Part Number 909306000 (KwikEE) or Part Number 369243 (LCI).

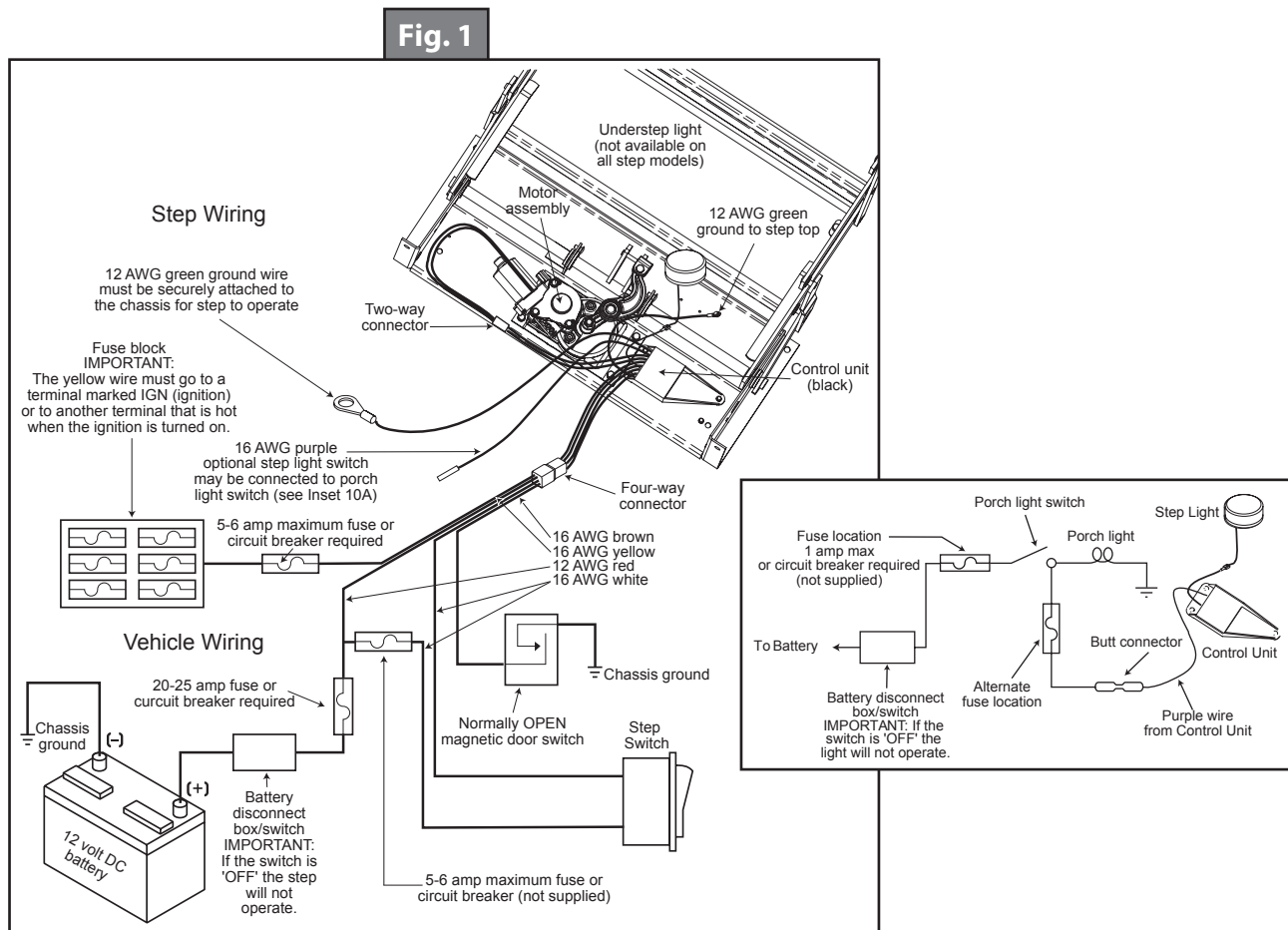

If all of the step functions do work, the malfunction is either in the door switch, power switch, or the vehicle wiring. Proceed to "Testing the 4-way Connector" section.

Testing The Motor

⚠ WARNING

Do not leave the wires connected during this test once the step has cycled either in or out. Failure to remove the wires from the battery will burn out the motor voiding any warranty.

Disconnect The 2-Way Connector Between The Step Motor And The Control Unit

1. Connect the red motor wire to the positive battery terminal and touch the yellow motor wire to the negative battery terminal to extend the step. To retract the step, reverse the connections. If the step extends and retracts during this test, the condition of the step motor is good. To retract the step, reverse the connections. If the step extends and retracts during this test, the condition of the step motor is good.

NOTE: On steps with reverse polarity plug Part Number 1800711 (Kwikee) or Part Number 365884 (LCI) reverse the red and yellow wire connections to perform the previous test.

Fig. 4

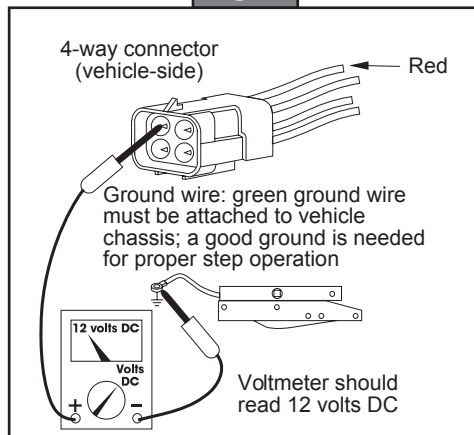

Fig. 5

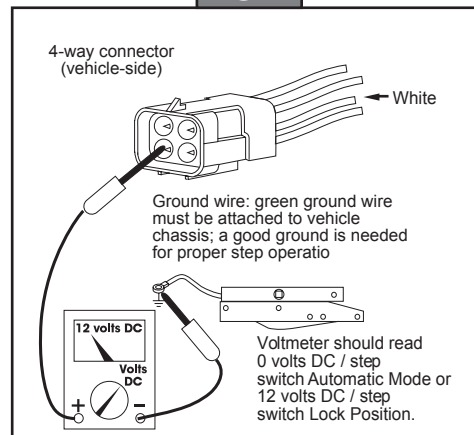
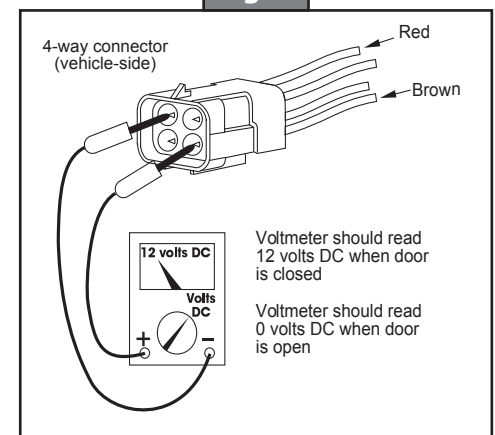

Fig. 6



Testing The 4-Way Connector

⚠ WARNING

Do not leave the wires connected during this test once the step has cycled either in or out. Failure to remove the wires from the battery will burn out the motor voiding any warranty.

1. To check the main power source, connect a voltmeter between the red wire from the 4-way connector (vehicle half) and the ground terminal at the end of the control unit's green ground wire (Fig. 4). The reading should be a minimum of 12 volts DC.

If the voltmeter reading is low, there may be a loose or corroded connection at the battery, a low charge level on the battery itself, or a poor ground. If the voltage reading is 0 volts, check the step fuse/circuit breaker, all connections, and the condition of the wiring between the battery and the plug, including the ground connection at the chassis.

2. To check the override switch, connect a voltmeter between the white wire from the 4-way connector (vehicle half) and the terminal at the end of the control unit green ground wire (Fig. 5). The reading should be a minimum of 12 volts DC when the switch is on, and 0 volts DC when the switch is off.

If the voltmeter reads 0 volts when the override switch is on, there is a problem in the override switch circuit. Check the 6 amp in-line fuse, the override switch itself and the condition of the circuit wiring and terminal connections.

3. To check the door switch, connect a voltmeter between the red wire from the 4-way connector (vehicle half) and the brown in the same connector (Fig. 6). The voltage should be a minimum of 12 volts DC when the door is closed and 0 volts DC when the door is open.

If the readings are incorrect, there is a problem with the switch. Check the door switch and the condition of the circuit's wiring and terminal connections.

4. To check the ignition override system, connect a voltmeter between the yellow wire from the 4-way connector (vehicle half) and the ground terminal on the end of the control unit green ground wire (Fig. 7). The voltage reading should be approximately 12 volts DC when ignition is on and 0 volts when ignition is off.

If the reading is zero when the ignition is on, check all terminal connections, wiring, and the vehicle ignition fuse.

NOTE: The step wiring circuit must be independent. No other device (i.e. alarm systems, step well lights, etc.) can be connected to the step wiring circuit. Any device connected to the steps wiring can cause the step to malfunction and will void the warranty.

5. For steps equipped with door switch only operation: Connect the white jumper wire from the vehicle half of the 4-way connector and the ground terminal at the end of the control unit's green ground wire (Fig. 8).

NOTE: Be sure to use the terminal with only the white wire. The reading should be 0 volts DC. If the voltage reading is more, the white wire is connected to 12 volts DC and should be cut.

If you have additional questions or need more assistance, contact Lippert Components, Inc. Customer Service at 1-574-537-8900.

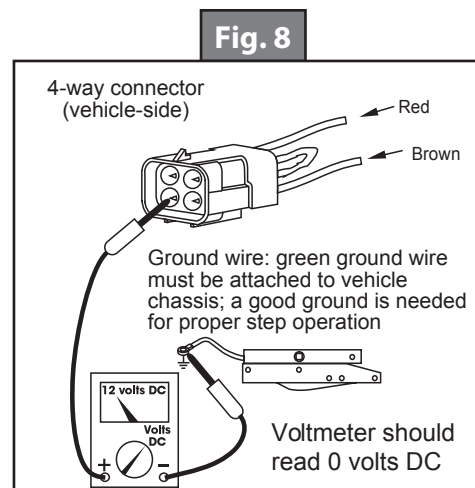
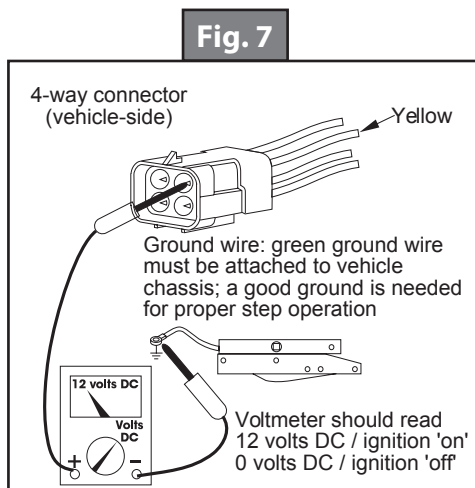

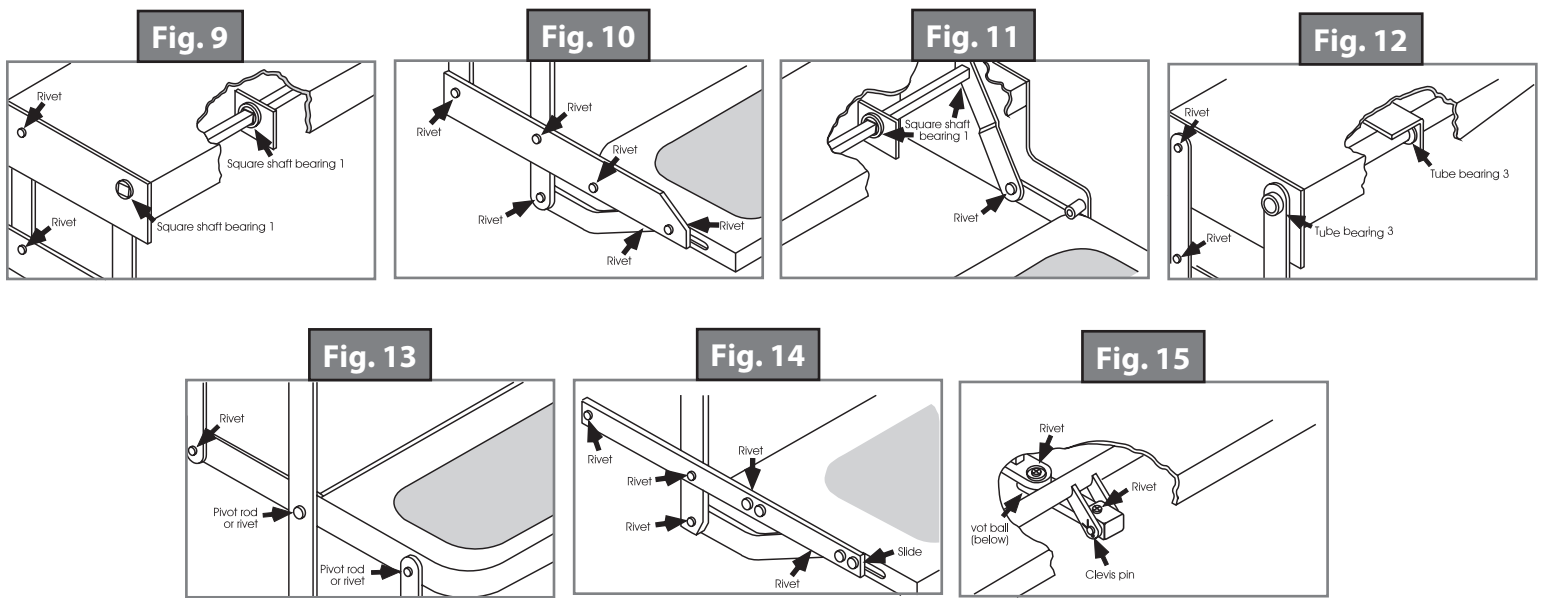

Maintenance

Step Motor Assembly Lubrication

Clean all mud, salt, and road grime from the step before lubricating. Lubricate all moving parts (bearings, pivot points, slides, clevis pin, and drive linkage ball) every 30 days with a good quality moisture and heat resistant penetrating grease. KwikLube™ Spray Grease is specially formulated to lubricate Kwikkee Electric Steps and is recommended for lubricating all moving parts. Refer to the figures below for lubrication locations.

NOTE: Silicone lubricants and WD-40® are not recommended as they have a tendency to evaporate and dry the mating surfaces which leave them vulnerable to the elements.

1. On the square shaft bearing, lubricate around outside (Fig. 9) and under head of bearing (Fig. 11).
2. On step models equipped with a plastic cover, this cover will have to be removed to lubricate center bearings (Fig. 12). Lubricate bearings under cover every 90 days.
3. Lubricate around the bushing-in-bushings (Fig.12).
4. Maintain clean, dry electrical connections at the 2-way and 4-way connectors and any butt connections leading from the 4 connectors on the vehicle. A small dab of dielectric grease at the connections and replacing corroded butt connections with heat shrink type crimp style automotive connectors will help maintain a good electrical source for the step.

NOTE: Figures are to be used for general reference purposes only. Some may not pertain to your particular step model.

Maintenance In A Salt Environment

To maintain step finish when step is exposed to a salt environment for extended periods of time, routinely spray with fresh water.



L I P P E R T C O M P O N E N T S[®]

The contents of this manual are proprietary and copyright protected by Lippert Components, Inc. ("LCI"). LCI prohibits the copying or dissemination of portions of this manual unless prior written consent from an authorized LCI representative has been provided. Any unauthorized use shall void any applicable warranty. The information contained in this manual is subject to change without notice and at the sole discretion of LCI.

Revised editions are available for free download from lci1.com.

Please recycle all obsolete materials.

For all concerns or questions, please contact
Lippert Components, Inc.

Ph: (574) 537-8900 | Web: lci1.com | Email: customerservice@lci1.com