

2018 **F-Series Super Duty Class A Motorhome**  
**and Commercial Chassis Owner's Manual**



owner.ford.com



ford.ca

January 2018  
Second Printing  
Owner's Manual  
Motorhome  
Litho in U.S.A.



JU9J19A321 AA



The information contained in this publication was correct at the time of going to print. In the interest of continuous development, we reserve the right to change specifications, design or equipment at any time without notice or obligation. No part of this publication may be reproduced, transmitted, stored in a retrieval system or translated into any language in any form by any means without our written permission. Errors and omissions excepted.

© Ford Motor Company 2017

All rights reserved.

Part Number: 201712 20171201180114



# Table of Contents

---

## Introduction

About This Manual .....	5
Symbols Glossary .....	5
California Proposition 65 .....	7
Perchlorate .....	7
Ford Credit .....	8
Replacement Parts Recommendation .....	8
Special Notices .....	8
Mobile Communications Equipment .....	9
Export Unique Options .....	10

## Environment

Protecting the Environment .....	11
----------------------------------	----

## Steering Wheel

Adjusting the Steering Wheel .....	12
Cruise Control .....	12

## Wipers and Washers

Windshield Wipers .....	13
Windshield Washers .....	13

## Lighting

Lighting Control .....	14
Instrument Lighting Dimmer .....	14
Daytime Running Lamps .....	15
Direction Indicators .....	15

## Instrument Cluster

Gauges .....	16
Warning Lamps and Indicators .....	18
Audible Warnings and Indicators .....	20

## Information Displays

General Information .....	21
Information Messages .....	22

## Starting and Stopping the Engine

General Information .....	25
Ignition Switch .....	25
Starting a Gasoline Engine .....	25
Engine Block Heater .....	27

## Fuel and Refueling

Safety Precautions .....	28
Fuel Quality .....	28
Running Out of Fuel .....	29
Refueling .....	29
Fuel Consumption .....	31

## Engine Emission Control

Emission Law .....	33
Catalytic Converter .....	34

## Transmission

Automatic Transmission .....	37
------------------------------	----

## Brakes

General Information .....	40
Hints on Driving With Anti-Lock Brakes .....	40
Parking Brake .....	41

## Cruise Control

Principle of Operation .....	42
Using Cruise Control .....	42

## Load Carrying

Load Limit .....	43
------------------	----

## Towing

Towing a Trailer .....	48
Recommended Towing Weights .....	49
Essential Towing Checks .....	51
Towing the Vehicle on Four Wheels .....	53

# Table of Contents

---

## Driving Hints

Breaking-In .....	54
Reduced Engine Performance .....	54
Economical Driving .....	54
Driving Through Water .....	55

## Roadside Emergencies

Roadside Assistance .....	56
Hazard Flashers .....	57
Jump Starting the Vehicle .....	57
Transporting the Vehicle .....	59

## Customer Assistance

Getting the Services You Need .....	61
In California (U.S. Only) .....	62
The Better Business Bureau (BBB) Auto Line Program (U.S. Only) .....	63
Utilizing the Mediation/Arbitration Program (Canada Only) .....	64
Getting Assistance Outside the U.S. and Canada .....	64
Ordering Additional Owner's Literature .....	65
Reporting Safety Defects (U.S. Only) .....	66
Reporting Safety Defects (Canada Only) .....	66

## Fuses

Fuse Specification Chart .....	68
Changing a Fuse .....	87

## Maintenance

General Information .....	89
Under Hood Overview - Commercial Chassis .....	89
Under Hood Overview - Motorhome Chassis .....	90
Engine Oil Dipstick .....	91
Engine Oil Check .....	91
Oil Change Indicator Reset .....	93

Engine Coolant Check .....	93
Automatic Transmission Fluid Check .....	97
Brake Fluid Check .....	99
Power Steering Fluid Check .....	100
Fuel Filter .....	101
Changing the 12V Battery .....	101
Changing the Engine Air Filter .....	103

## Vehicle Care

General Information .....	105
Cleaning the Exterior .....	105
Cleaning the Engine .....	106
Cleaning the Wheels .....	106
Vehicle Storage .....	106

## Wheels and Tires

Tire Care .....	109
Using Snow Chains .....	124
Changing a Road Wheel .....	125
Technical Specifications .....	128

## Capacities and Specifications

Engine Specifications .....	129
Motorcraft Parts .....	129
Vehicle Identification Number .....	131
Vehicle Certification Label .....	132
Transmission Code Designation .....	132
Capacities and Specifications .....	133

## Ford Protect

Ford Protect .....	138
--------------------	-----

## Scheduled Maintenance

General Maintenance Information .....	140
Normal Scheduled Maintenance .....	143
Special Operating Conditions Scheduled Maintenance .....	145
Scheduled Maintenance Record .....	147

# Table of Contents

---

## **Appendices**

Type Approvals .....	158
----------------------	-----



# Introduction

## ABOUT THIS MANUAL

Thank you for choosing Ford. We recommend that you take some time to get to know your vehicle by reading this manual. The more that you know about your vehicle, the greater the safety and pleasure you will get from driving it.

### WARNING



Driving while distracted can result in loss of vehicle control, crash and injury. We strongly recommend that you use extreme caution when using any device that may take your focus off the road. Your primary responsibility is the safe operation of your vehicle. We recommend against the use of any hand-held device while driving and encourage the use of voice-operated systems when possible. Make sure you are aware of all applicable local laws that may affect the use of electronic devices while driving.

**Note:** *This manual describes product features and options available throughout the range of available models, sometimes even before they are generally available. It may describe options not fitted to the vehicle you have purchased.*

**Note:** *Some of the illustrations in this manual may show features as used in different models, so may appear different to you on your vehicle.*

**Note:** *Always use and operate your vehicle in line with all applicable laws and regulations.*

**Note:** *Pass on this manual when selling your vehicle. It is an integral part of your vehicle.*

**Note:** *Either Ford Motor Company or an authorized Ford dealer may have originally sold this incomplete vehicle to a vehicle modifier who upfitted it. As a result, it may have different options and features than described in this manual.*

This manual may qualify the location of a component as left-hand side or right-hand side. The side is determined when facing forward in the seat.



E154903

- A Right-hand side.
- B Left-hand side.

## SYMBOLS GLOSSARY

These are some of the symbols you may see on your vehicle.



Air conditioning system



Air conditioning system lubricant type



Anti-lock braking system



Avoid smoking, flames or sparks



# Introduction



Battery



Engine oil



Battery acid



Explosive gas



Brake fluid - non petroleum based



Fan warning



Brake system



Fasten seatbelt



Cabin air filter



Flammable



Check fuel cap



Front airbag



Child safety door lock or unlock



Front fog lamps



Child seat lower anchor



Fuel pump reset



Child seat tether anchor



Fuse compartment



Cruise control



Hazard warning flashers



Do not open when hot



Heated rear window



Engine air filter



Heated windshield



Engine coolant



Interior luggage compartment release



Engine coolant temperature



Jack



Keep out of reach of children

# Introduction

---



Lighting control



Low tire pressure warning



Maintain correct fluid level



Note operating instructions



Panic alarm



Parking aid



Parking brake



Power steering fluid



Power windows front/rear



Power window lockout



Requires registered technician



Safety alert



See Owner's Manual



See Service Manual



Service engine soon



Side airbag



Shield the eyes



Stability control



Windshield wash and wipe

## CALIFORNIA PROPOSITION 65

### WARNINGS



Some constituents of engine exhaust, certain vehicle components, certain fluids contained in vehicles and certain products of component wear contain or emit chemicals known to the State of California to cause cancer and birth defects or other reproductive harm.



Battery posts, terminals and related accessories contain lead and lead compounds, chemicals known to the State of California to cause cancer and reproductive harm. Batteries also contain other chemicals known to the State of California to cause cancer. Wash your hands after handling.

## PERCHLORATE

Certain components in your vehicle such as airbag modules, seatbelt pretensioners and remote control batteries may contain perchlorate material. Special handling may apply for service or vehicle end of life disposal.

# Introduction

---

**For more information visit:**

Web Address
<a href="http://www.dtsc.ca.gov/hazardouswaste/perchlorate">www.dtsc.ca.gov/hazardouswaste/perchlorate</a>

## FORD CREDIT

### US Only

Ford Credit offers a full range of financing and lease plans to help you acquire your vehicle. If you have financed or leased your vehicle through Ford Credit, thank you for your business.

We offer a number of convenient ways for you to contact us, and to manage your account.

Call 1-800-727-7000.

For more information about Ford Credit and access to Account Manager, go to [www.ford.com/finance](http://www.ford.com/finance).

## REPLACEMENT PARTS RECOMMENDATION

We have built your vehicle to the highest standards using quality parts. We recommend that you demand the use of genuine Ford and Motorcraft parts whenever your vehicle requires scheduled maintenance or repair. You can clearly identify genuine Ford and Motorcraft parts by looking for the Ford, FoMoCo or Motorcraft branding on the parts or their packaging.

## Scheduled Maintenance and Mechanical Repairs

One of the best ways for you to make sure that your vehicle provides years of service is to have it maintained in line with our recommendations using parts that conform to the specifications detailed in this Owner's Manual. Genuine Ford and Motorcraft parts meet or exceed these specifications.

### Collision Repairs

We hope that you never experience a collision, but accidents do happen. Genuine Ford replacement collision parts meet our stringent requirements for fit, finish, structural integrity, corrosion protection and dent resistance. During vehicle development we validate that these parts deliver the intended level of protection as a whole system. A great way to know for sure you are getting this level of protection is to use genuine Ford replacement collision parts.

### Warranty on Replacement Parts

Genuine Ford and Motorcraft replacement parts are the only replacement parts that benefit from a Ford Warranty. The Ford Warranty may not cover damage caused to your vehicle as a result of failed non-Ford parts. For additional information, refer to the terms and conditions of the Ford Warranty.

## SPECIAL NOTICES

### New Vehicle Limited Warranty

For a detailed description of what is covered and what is not covered by your vehicle's New Vehicle Limited Warranty, see the Warranty Manual that is provided to you along with your Owner's Manual.

# Introduction

---

## Special Instructions

For your added safety, your vehicle is fitted with sophisticated electronic controls.

### WARNINGS



You risk death or serious injury to yourself and others if you do not follow the instruction highlighted by the warning symbol. Failure to follow the specific warnings and instructions could result in personal injury.



NEVER use a rearward facing child restraint on a seat protected by an ACTIVE AIRBAG in front of it, DEATH or SERIOUS INJURY to the CHILD can occur.

---

## On Board Diagnostics Data Link Connector

### WARNING



Do not connect wireless plug-in devices to the data link connector. Unauthorized third parties could gain access to vehicle data and impair the performance of safety related systems. Only allow repair facilities that follow our service and repair instructions to connect their equipment to the data link connector.

Your vehicle has an OBD Data Link Connector (DLC) that is used in conjunction with a diagnostic scan tool for vehicle diagnostics, repairs and reprogramming services. Installing an aftermarket device that uses the DLC during normal driving for purposes such as remote insurance company monitoring, transmission of vehicle data to other devices or entities, or altering the performance of the vehicle, may cause

interference with or even damage to vehicle systems. We do not recommend or endorse the use of aftermarket plug-in devices unless approved by Ford. The vehicle Warranty will not cover damage caused by an aftermarket plug-in device.

## MOBILE COMMUNICATIONS EQUIPMENT

### WARNING



Driving while distracted can result in loss of vehicle control, crash and injury. We strongly recommend that you use extreme caution when using any device that may take your focus off the road. Your primary responsibility is the safe operation of your vehicle. We recommend against the use of any hand-held device while driving and encourage the use of voice-operated systems when possible. Make sure you are aware of all applicable local laws that may affect the use of electronic devices while driving.

Using mobile communications equipment is becoming increasingly important in the conduct of business and personal affairs. However, you must not compromise your own or others' safety when using such equipment. Mobile communications can enhance personal safety and security when appropriately used, particularly in emergency situations. Safety must be paramount when using mobile communications equipment to avoid negating these benefits. Mobile communication equipment includes, but is not limited to, cellular phones, pagers, portable email devices, text messaging devices and portable two-way radios.

# Introduction

---

## EXPORT UNIQUE OPTIONS

For your particular global region, your vehicle may be equipped with features and options that are different from the features and options that are described in this Owner's Manual. A market unique supplement may be supplied that complements this book. By referring to the market unique supplement, if provided, you can properly identify those features, recommendations and specifications that are unique to your vehicle. This Owner's Manual is written primarily for the U.S. and Canadian Markets. Features or equipment listed as standard may be different on units built for export. **Refer to this Owner's Manual for all other required information and warnings.**

# Environment

---

## **PROTECTING THE ENVIRONMENT**

You should play your part in protecting the environment. Correct vehicle usage and the authorized disposal of waste, cleaning and lubrication materials are significant steps toward this aim.

**For details about Ford Motor Company's sustainability progress and initiatives visit:**

<b>Web Address</b>
<a href="http://www.sustainability.ford.com">www.sustainability.ford.com</a>

# Steering Wheel

## ADJUSTING THE STEERING WHEEL

### WARNING

 Do not adjust the steering wheel when your vehicle is moving.

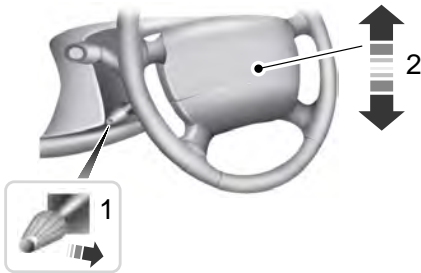

E161517

1. Pull and hold the steering wheel release lever.
2. Adjust the steering wheel to the position you desire, then release the lever.

## CRUISE CONTROL



E161518

See **Cruise Control** (page 42).

# Wipers and Washers

## WINDSHIELD WIPERS

**Note:** Fully defrost the windshield before you switch the windshield wipers on.

**Note:** Make sure you switch the windshield wipers off before entering a car wash.

**Note:** If streaks or smears appear on the windshield, clean the windshield and the wiper blades. If that does not resolve the issue, install new wiper blades.

**Note:** Do not operate the wipers on a dry windshield. This may scratch the glass, damage the wiper blades or cause the wiper motor to burn out. Always use the windshield washers before wiping a dry windshield.

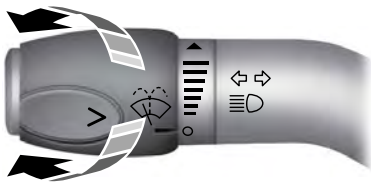

E161461

Rotate away from you for long wipe interval.

Toward you for short wipe interval.

Use the rotary control to adjust the intermittent wipe interval.

## WINDSHIELD WASHERS

**Note:** Do not operate the wipers on a dry windshield. This may scratch the glass, damage the wiper blades or cause the wiper motor to burn out. Always use the windshield washer before wiping a dry windshield.

**Note:** Do not operate the washers when the washer reservoir is empty. This may cause the washer pump to overheat.

Press the end of the stalk to activate the washer.

- A brief press causes a single wipe without washer fluid.
- A quick press and hold causes the wipers to swipe three times with washer fluid.
- A long press and hold will activate the wipers and washer fluid for up to 10 seconds.



E161462



# Lighting

## LIGHTING CONTROL

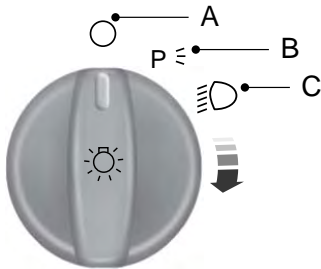

E161456

- A Off.
- B Parking lamps, instrument panel lamps, license plate lamps and tail lamps.
- C Headlamps.

## High Beams

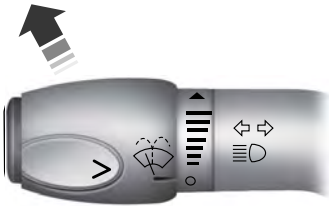

E161457

Push the lever away from you to switch the high beam on.

Push the lever forward again or pull the lever toward you to switch the high beams off.

## Headlamp Flasher

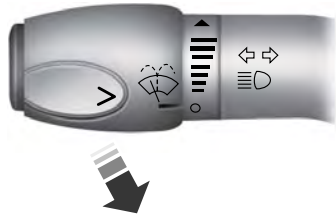

E161458

Slightly pull the lever toward you and release it to flash the headlamps.

## INSTRUMENT LIGHTING DIMMER

**Note:** If you disconnect the battery or it becomes discharged, the dimmer switch requires re-calibration. Rotate the dimmer switch from the full dim position to the full dome/on position to reset.

**Note:** Rotate to the full upright position, past detent, to switch on the interior lamps.

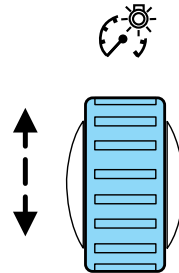

E161459

Rotate up or down to adjust the intensity of the panel lighting.

## DAYTIME RUNNING LAMPS

### WARNING



The daytime running lamps system does not activate the rear lamps and may not provide adequate lighting during low visibility driving conditions. Make sure you switch the headlamps on, as appropriate, during all low visibility conditions. Failure to do so may result in a crash.

The system turns the lamps on in daylight conditions.

To switch the system on, switch the lighting control to the off, autolamp or parking lamp position.

## DIRECTION INDICATORS



E161460

Push the lever up or down to use the direction indicators.

**Note:** Tap the lever up or down to make the direction indicators flash three times to indicate a lane change.

# Instrument Cluster

## GAUGES

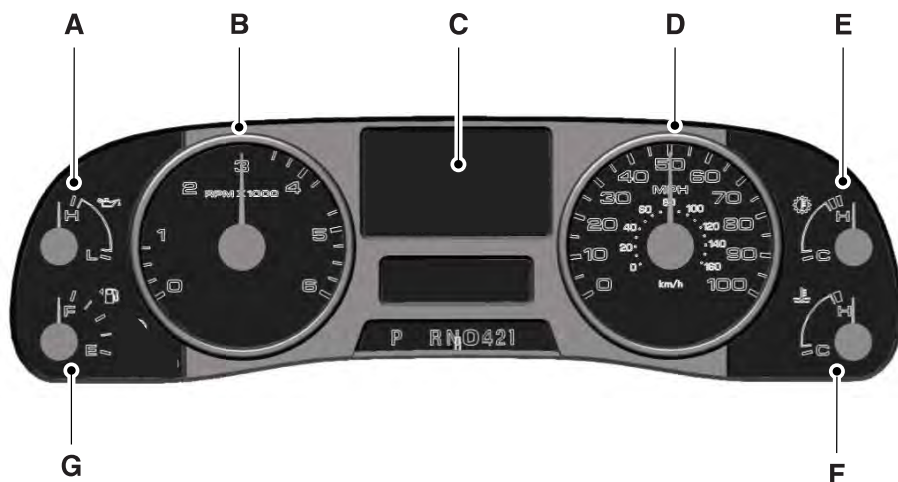

E192271

- A Engine oil pressure gauge.
- B Tachometer.
- C Information display.
- D Speedometer.
- E Transmission fluid temperature gauge.
- F Engine coolant temperature gauge.
- G Fuel gauge.

### Engine Oil Pressure Gauge

Indicates engine oil pressure. The needle should stay in the normal operating range (between L and H). If the needle falls below the normal range, stop the vehicle, turn off the engine and check the engine oil level. Add oil if needed. If the oil level is correct, have your vehicle checked by your authorized dealer.

### Speedometer

Indicates vehicle speed. Vehicle speed is limited to either 65 mph (105 km/h) or 75 mph (120 km/h).

# Instrument Cluster

## Transmission Fluid Temperature Gauge

### Normal area

The transmission fluid is within the normal operating temperature (between H and C).

### Yellow area

The transmission fluid is higher than normal operating temperature. This can be caused by special operation conditions (i.e. snowplowing, towing or off-road use). Operating the transmission for extended periods of time with the gauge in the yellow area may cause internal transmission damage. Altering the severity of the driving conditions is recommended to lower the transmission temperature into the normal range.

### Red area

The transmission fluid is overheating. Stop the vehicle to allow the temperature to return to normal range.

If the gauge is operating in the yellow or red area, stop the vehicle and verify the airflow is not restricted such as snow or debris blocking airflow through the grille. If the gauge continues to show high temperatures, see your authorized dealer.

## Engine Coolant Temperature Gauge

### WARNING



Do not remove the coolant reservoir cap when the cooling system is hot. Wait 10 minutes for the cooling system to cool down. Cover the coolant reservoir cap with a thick cloth to prevent the possibility of scalding and slowly remove the cap. Failure to follow this instruction could result in personal injury.

At normal operating temperature, the needle remains in the center section.

**Note:** *Do not restart the engine until the cause of overheating has been resolved.*

If the needle enters the red section, the engine is overheating. Stop the engine, switch the ignition off and determine the cause once the engine has cooled down.

## Fuel Gauge

**Note:** *The fuel gauge may vary slightly when your vehicle is moving or on a slope.*

Switch the ignition on. The fuel gauge indicates approximately how much fuel you have left in the fuel tank. The arrow adjacent to the fuel pump symbol indicates on which side of your vehicle the fuel filler door is located.

The needle should move toward F when you refuel your vehicle. If the needle points to E after adding fuel, have an authorized dealer check the system soon.

After refueling, some variability in the position of the needle is normal:

- It may take a short time for the needle to reach F after leaving the gas station. This is normal and depends upon the slope of the pavement at the gas station.
- The fuel amount dispensed into the tank is a little less or more than the gauge indicated. This is normal and depends upon the slope of the pavement at the gas station.
- If the gas station nozzle shuts off before the tank is full, try a different gas pump nozzle.
- There is a small reserve left in the tank when the fuel gauge reaches empty.

# Instrument Cluster

## Low Fuel Reminder

A low fuel reminder triggers when the fuel gauge needle is at one-sixteenth or about

50 mi (80 km), 25 mi (40 km), 10 mi (16 km) and 0 mi (0 km) to empty, whichever occurs first.

### Variations:

**Note:** *The low fuel warning and distance-to-empty warning can appear at different fuel gauge positions depending on fuel economy conditions. This variation is normal.*

Driving type (fuel economy conditions)	Fuel gauge position	Distance-to-empty
Highway driving	1/16th	30–80 mi (48–129 km)
Severe duty driving (trailer towing, extended idle)	1/16th-1/4	10–35 mi (16–56 km)

## WARNING LAMPS AND INDICATORS

The following warning lamps and indicators alert you to a vehicle condition that may become serious. Some lamps illuminate when you start your vehicle to make sure they work. If any lamps remain on after starting your vehicle, refer to the respective system warning lamp for further information.

**Note:** *Some warning indicators appear in the information display and operate the same as a warning lamp but do not illuminate when you start your vehicle.*

### Anti-Lock Brake System Warning Lamp



If it illuminates when you are driving, this indicates a malfunction. You will continue to have the normal braking system (without ABS) unless the brake system warning lamp is also illuminated. Have the system checked by your authorized dealer.

### Battery



If it illuminates while driving, it indicates a malfunction. Switch off all unnecessary electrical equipment and have the system checked by your authorized dealer immediately.

### Brake System Warning Lamp

#### WARNING



Driving your vehicle with the warning lamp on is dangerous. A significant decrease in braking performance may occur. It may take you longer to stop your vehicle. Have your vehicle checked as soon as possible. Driving extended distances with the parking brake engaged can cause brake failure and the risk of personal injury.



It illuminates when you engage the parking brake and the ignition is on.

# Instrument Cluster

If it illuminates when your vehicle is moving, make sure the parking brake is disengaged. If the parking brake is disengaged, this indicates low brake fluid level or a brake system fault. Have your vehicle checked as soon as possible.

## Brake Reserve System (If Equipped)



Illuminates to indicate normal hydromax booster reserve system activation when the engine is off and the service brake pedal is applied.

This light may also illuminate momentarily if the engine is running and the driver turns the steering wheel fully in one direction while braking.

If the light remains on while the engine is running, this indicates inadequate hydraulic booster pressure or reserve pump system failure. Stop the vehicle as soon as possible and seek service immediately by your authorized dealer.

## Cruise Control Indicator (If Equipped)



Illuminates when you switch this feature on. See **Using Cruise Control** (page 42).

## Direction Indicator



Illuminates when the left or right direction indicator or the hazard warning flasher is turned on. If the indicators stay on or flash faster, check for a burned out bulb.

## Electronic Throttle Control



Illuminates when the engine has defaulted to a limp-home operation. See your authorized dealer as soon as possible.

## Fasten Seatbelt Warning Lamp



It illuminates and a chime sounds until you fasten the seatbelts.

## Headlamp High Beam Indicator



Illuminates when you switch the high beam headlamps on. It will flash when you use the headlamp flasher.

## Service Engine Soon



If it illuminates when the engine is running this indicates a malfunction. The On Board Diagnostics system has detected a malfunction of the vehicle emission control system.

If it flashes, engine misfire may be occurring. Increased exhaust gas temperatures could damage the catalytic converter or other vehicle components. Drive in a moderate fashion (avoid heavy acceleration and deceleration) and have your vehicle immediately serviced.

It illuminates when you switch the ignition on prior to engine start to check the bulb and to indicate whether your vehicle is ready for Inspection and Maintenance (I/M) testing.

Normally, it illuminates until the engine is cranked and automatically turns off if no malfunctions are present. However, if after 15 seconds it flashes eight times, this indicates that your vehicle is not ready for Inspection and Maintenance (I/M) testing. See **Emission Law** (page 33).

# Instrument Cluster

---

## Tow Haul Indicator



Illuminates when the tow/haul feature has been activated. If the light flashes steadily, have the system serviced immediately, damage to the transmission could occur.

## Shift to Park Warning Chime

Sounds when you open the driver's door and your vehicle is not in park.

## AUDIBLE WARNINGS AND INDICATORS

### Fail-Safe Cooling Warning Chime

Sounds when the coolant gauge pointer has moved to hot. There are three stages of chimes:

- Stage 1 is a single chime when the engine temperature begins to overheat.
- Stage 2 is multiple chimes and engine power becomes limited in order to help cool the engine.
- Stage 3 is multiple chimes and the engine will shut down.

### Headlamps On Warning Chime

Sounds when you remove the key from the ignition and open the driver's door and you have left the headlamps or parking lamps on.

### Key in Ignition Warning Chime

Sounds when you open the driver's door and you have left the key in the ignition.

### Parking Brake On Warning Chime

Sounds when you have left the parking brake on and drive your vehicle. If the warning chime remains on after you have released the parking brake, have the system checked by your authorized dealer immediately.

# Information Displays

## GENERAL INFORMATION

### WARNING



Driving while distracted can result in loss of vehicle control, crash and injury. We strongly recommend that you use extreme caution when using any device that may take your focus off the road. Your primary responsibility is the safe operation of your vehicle. We recommend against the use of any hand-held device while driving and encourage the use of voice-operated systems when possible. Make sure you are aware of all applicable local laws that may affect the use of electronic devices while driving.

You can control various systems on your vehicle using the information display controls on the steering wheel. The information display shows the corresponding information.

## Information Display Controls



E197545

- Press the info button to scroll through trip, outside air temperature, engine hours and miles to empty.
- Press the setup button to scroll through various vehicle feature settings.
- Press the reset button to choose settings, reset information and confirm messages.

## Info



E161507

Press the INFO button repeatedly to cycle through the following features:

### TRIP

Registers the distance of individual journeys. Press and release the INFO button until the TRIP appears in the display. Press and hold the RESET button to reset

### XXX° (outside air temperature)

This displays the outside temperature.

### MILES (km) TO E

This displays an estimate of approximately how far you can drive with the fuel remaining in your tank under normal driving conditions. Remember to turn the ignition off when refueling to allow this feature to correctly detect the added fuel.



# Information Displays

The DTE function will display a message in the information display when you have approximately 50 mi (80 km) to empty. Press RESET to clear this warning message. It will return at approximately 25 mi (40 km), 10 mi (16 km) and 0 mi (0 km) miles to empty.

DTE calculates using a running average fuel economy based on your recent driving history of 500 mi (800 km).

## ENG HRS

Registers the accumulated time the engine has been running.

## System check and vehicle feature customization



E161508

Press the SETUP button repeatedly to cycle the message center through the following features:

### PRESS RESET FOR SYS CHECK

When this message appears, press the RESET button and the message center will begin to cycle through the following systems and provide a status of the item if needed.

**Note:** Some systems show a message only if a condition is present

- ENGINE TEMP
- TRANS TEMP
- OIL PRESSURE
- BRAKE FLUID LEVEL
- FUEL LEVEL (if equipped)

## UNITS

Displays the current units English or Metric. Press the RESET button to change from English to Metric.

## ENGLISH RESET FOR NEW

Allows you to choose which language the message center will display in. Selectable languages are English, Spanish, or French.

Press the RESET button to cycle the message center through English, Spanish and French language choices. Press and hold the RESET button for two seconds to set the language choice.

**Note:** When you select a non-English language, a *HOLD RESET FOR ENGLISH* message displays when you return to the *SETUP* menu. Press and hold the *RESET* button to change back to English.

## INFORMATION MESSAGES

**Note:** Depending on the vehicle options equipped with your vehicle, not all of the messages will display or be available. Certain messages may be abbreviated or shortened depending upon which cluster type you have.

Press the RESET button to acknowledge and remove some messages from the information display. Other messages will be removed automatically after a short time.

Certain messages need to be confirmed before you can access the menus.

# Information Displays

## Engine

Message	Action
REDUCED ENGINE POWER	The engine is overheating. Stop your vehicle as soon as safely possible, turn off the engine. If the warning stays on followed by an indicator chime or continues to come on, contact an authorized dealer as soon as possible. Never remove the coolant reservoir cap while the engine is running or hot.
STOP ENGINE SAFELY	The engine is overheating. Stop your vehicle as soon as safely possible, turn off the engine. If the warning stays on followed by an indicator chime or continues to come on, contact an authorized dealer as soon as possible.
CHECK ENGINE TEMPERATURE	The engine coolant is overheating. Stop your vehicle as soon as safely possible, turn off the engine and let it cool. Check the coolant and coolant level. If the warning stays on or continues to come on, contact an authorized dealer as soon as possible.
FUEL LEVEL LOW	A early reminder of a low fuel condition.

## Maintenance

Message	Action
LOW OIL PRESSURE	The engine oil pressure is low. Check the level of the engine oil. If the oil level is OK and this warning persists, shut down the engine immediately and contact an authorized dealer as soon as possible. See <b>Engine Oil Check</b> (page 91).
BRAKE FLUID LEVEL LOW	The brake fluid level is low and the brake system should be inspected immediately. See <b>Brake Fluid Check</b> (page 99).
CHECK FUEL CAP	The fuel cap is loose, not seated properly or off. Stop your vehicle when convenient, turn off the engine and check that you inserted the fuel cap properly. Rotate the cap until you hear a click. The warning message switches off after a proper drive cycle is completed. See <b>Emission Law</b> (page 33). If the warning message remains on or continues to comes back on, see an authorized dealer as soon as possible.

# Information Displays

---

## Transmission

<b>Message</b>	<b>Action</b>
CHECK TRANS TEMPERATURE	The transmission fluid is overheating. This warning may appear when towing heavy loads or when driving in a low gear at a high speed for an extended period of time. Stop your vehicle as soon as safely possible, turn off the engine and let the transmission cool.
SHIFT TO PARK	A reminder to apply the brakes, then shift to park.

# Starting and Stopping the Engine

## GENERAL INFORMATION

### WARNINGS



Extended idling at high engine speeds can produce very high temperatures in the engine and exhaust system, creating the risk of fire or other damage.



Do not park, idle or drive your vehicle on dry grass or other dry ground cover. The emission system heats up the engine compartment and exhaust system, creating the risk of fire.



Do not start the engine in a closed garage or in other enclosed areas. Exhaust fumes can be toxic. Always open the garage door before you start the engine.



Exhaust leaks may result in entry of harmful and potentially lethal fumes into the passenger compartment. If you smell exhaust fumes inside your vehicle, have your vehicle inspected immediately. Do not drive if you smell exhaust fumes.

If you disconnect the battery, your vehicle may exhibit some unusual driving characteristics for approximately 5 mi (8 km) after you reconnect it. This is because the engine management system must realign itself with the engine. You can disregard any unusual driving characteristics during this period.

The powertrain control system meets all Canadian interference-causing equipment standard requirements regulating the impulse electrical field or radio noise.

When you start the engine, avoid pressing the accelerator pedal before and during operation. Only use the accelerator pedal when you have difficulty starting the engine.

## IGNITION SWITCH

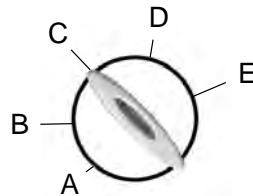

E161572

**A** (accessory) - Allows the electrical accessories, such as the radio, to operate while the engine is not running.

**Note:** Do not leave the ignition key in this position for too long. This could cause your vehicle battery to lose charge.

**B** (lock) - Locks the gearshift lever and allows key removal.

**C** (off) - The ignition is off.

**Note:** When you switch the ignition off and leave your vehicle, do not leave your key in the ignition. This could cause your vehicle battery to lose charge.

**D** (on) - All electrical circuits are operational and the warning lamps and indicators illuminate.

**E** (start) - Cranks the engine.

## STARTING A GASOLINE ENGINE

When you start the engine, the idle speed increases, this helps to warm up the engine. If the engine idle speed does not slow down automatically, have your vehicle checked by an authorized dealer.

# Starting and Stopping the Engine

---

Before starting the engine check the following:

- Make sure all occupants have fastened their safety belts.
- Make sure the headlamps and electrical accessories are off.
- Make sure the parking brake is on.
- Make sure the transmission is in park (P) or neutral (N).
- Turn the ignition key to the on position.

**Note:** *Do not touch the accelerator pedal.*

1. Fully press the brake pedal.
2. Turn the key to the start position to start the engine. Release the key when the engine starts.

**Note:** *The engine may continue cranking for up to 15 seconds or until it starts.*

**Note:** *If you cannot start the engine on the first try, wait for a short period and try again.*

## Failure to Start

If you cannot start the engine after three attempts, wait 10 seconds and follow this procedure:

1. Fully press the brake pedal.
2. Fully press the accelerator pedal and hold it there.
3. Start the engine.

## Stopping the Engine When Your Vehicle is Stationary

1. Shift into park (P) or neutral (N).
2. Turn the key to the off position.
3. Apply the parking brake.

## Stopping the Engine When Your Vehicle is Moving

### WARNING



Switching off the engine when the vehicle is still moving will result in a loss of brake and steering assistance. The steering will not lock, but higher effort will be required. When the ignition is switched off, some electrical circuits, including air bags, warning lamps and indicators may also be off. If the ignition was turned off accidentally, you can shift into neutral (N) and re-start the engine.

1. Put the transmission into neutral (N) and use the brakes to bring your vehicle to a safe stop.
2. When your vehicle has stopped, shift into park (P) or neutral (N) and switch the ignition off.
3. Apply the parking brake.

## Guarding Against Exhaust Fumes

### WARNING



If you smell exhaust fumes inside your vehicle, have your vehicle checked by your authorized dealer immediately. Do not drive your vehicle if you smell exhaust fumes. Carbon monoxide is present in exhaust fumes. Take precautions to avoid its dangerous effects.

## Important Ventilating Information

If you stop your vehicle and then leave the engine idling for long periods of time, we recommend that you do one of the following:

- Open the windows at least 1 in (3 cm).
- Set your climate control to outside air.

# Starting and Stopping the Engine

## ENGINE BLOCK HEATER (if

Equipped)

### WARNINGS



Failure to follow engine block heater instructions could result in property damage or serious personal injury.



Do not use your heater with ungrounded electrical systems or two-pronged adapters. There is a risk of electrical shock.



Do not fully close the hood, or allow it to drop under its own weight when using the engine block heater. This could damage the power cable and may cause an electrical short resulting in fire, injury and property damage.

**Note:** *The heater is most effective when outdoor temperatures are below 0°F (-18°C).*

The heater acts as a starting aid by warming the engine coolant. This allows the climate control system to respond quickly. The equipment includes a heater element (installed in the engine block) and a wire harness. You can connect the system to a grounded 120-volt AC electrical source.

We recommend that you do the following for a safe and correct operation:

- Use a 16-gauge outdoor extension cord that is product certified by Underwriter's Laboratory (UL) or Canadian Standards Association (CSA). This extension cord must be suitable for use outdoors, in cold

temperatures, and be clearly marked Suitable for Use with Outdoor Appliances. Do not use an indoor extension cord outdoors. This could result in an electric shock or become a fire hazard.

- Use as short an extension cord as possible.
- Do not use multiple extension cords.
- Make sure that when in operation, the extension cord plug and heater cord plug connections are free and clear of water. This could cause an electric shock or fire.
- Make sure your vehicle is parked in a clean area, clear of combustibles.
- Make sure the heater, heater cord and extension cord are firmly connected.
- Check for heat anywhere in the electrical hookup once the system has been operating for approximately 30 minutes.
- Make sure the system is unplugged and properly stowed before starting and driving your vehicle. Make sure the protective cover seals the prongs of the block heater cord plug when not in use.
- Make sure the heater system is checked for proper operation before winter.

## Using the Engine Block Heater

Make sure the receptacle terminals are clean and dry prior to use. Clean them with a dry cloth if necessary.

The heater uses 0.4 to 1.0 kilowatt-hours of energy per hour of use. The system does not have a thermostat. It achieves maximum temperature after approximately three hours of operation. Using the heater longer than three hours does not improve system performance and unnecessarily uses electricity.

# Fuel and Refueling

## SAFETY PRECAUTIONS

### WARNINGS

 Do not overfill the fuel tank. The pressure in an overfilled tank may cause leakage and lead to fuel spray and fire.

 The fuel system may be under pressure. If you hear a hissing sound near the fuel filler inlet, do not refuel until the sound stops. Otherwise, fuel may spray out, which could cause serious personal injury.

 Fuels can cause serious injury or death if misused or mishandled.

 Fuel may contain benzene, which is a cancer-causing agent.

 When refueling always shut the engine off and never allow sparks or open flames near the fuel tank filler valve. Never smoke or use a cell phone while refueling. Fuel vapor is extremely hazardous under certain conditions. Avoid inhaling excess fumes.

Follow these guidelines when refueling:

- Extinguish all smoking materials and any open flames before refueling your vehicle.
- Always switch the engine off before refueling.
- Automotive fuels can be harmful or fatal if swallowed. Fuel is highly toxic and if swallowed can cause death or permanent injury. If fuel is swallowed immediately call a physician, even if no symptoms are immediately apparent. The toxic effects of fuel may not be apparent for hours.

- Avoid inhaling fuel vapors. Inhaling fuel vapor can lead to eye and respiratory tract irritation. In severe cases, excessive or prolonged breathing of fuel vapor can cause serious illness and permanent injury.
- Avoid getting fuel in your eyes. If you splash fuel in your eyes, immediately remove contact lenses (if worn), flush with water for 15 minutes and seek medical attention. Failure to seek proper medical attention could lead to permanent injury.
- Fuels can be harmful if absorbed through the skin. If you splash fuel on your skin, clothing or both, promptly remove contaminated clothing and thoroughly wash your skin with soap and water. Repeated or prolonged skin contact causes skin irritation.
- Be particularly careful if you are taking Antabuse or other forms of Disulfiram for the treatment of alcoholism. Breathing fuel vapors could cause an adverse reaction, serious personal injury or sickness. Immediately call a physician if you experience any adverse reactions.

## FUEL QUALITY

### Choosing the Right Fuel

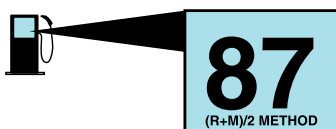

E161513

Your vehicle is designed to operate on regular unleaded gasoline with a minimum pump (R+M)/2 octane rating of 87.

# Fuel and Refueling

Some fuel stations, particularly those in high altitude areas, offer fuels posted as regular unleaded gasoline with an octane rating below 87. We do not recommend these fuels.

For best overall vehicle and engine performance, premium fuel with an octane rating of 91 or higher is recommended. The performance gained by using premium fuel is most noticeable in hot weather as well as other conditions, for example when towing a trailer. See **Towing** (page 48).

Do not be concerned if the engine sometimes knocks lightly. However, if the engine knocks heavily while using fuel with the recommended octane rating, contact an authorized dealer to prevent any engine damage.

Do not use any fuel other than those recommended because they could lead to engine damage that will not be covered by the vehicle Warranty.

**Note:** *Use of any fuel other than those recommended can impair the emission control system and cause a loss of vehicle performance.*

Do not use:

- Diesel fuel.
- Fuels containing kerosene or paraffin.
- Fuel containing more than 15% ethanol or E85 fuel.
- Fuels containing methanol.
- Fuels containing metallic-based additives, including manganese-based compounds.
- Fuels containing the octane booster additive, methylcyclopentadienyl manganese tricarbonyl (MMT).
- Leaded fuel, using leaded fuel is prohibited by law.

The use of fuels with metallic compounds such as methylcyclopentadienyl manganese tricarbonyl (commonly known as MMT), which is a manganese-based fuel additive, will impair engine performance and affect the emission control system.

We recommend Top Tier detergent gasolines to help minimize engine deposits and maintain optimal vehicle and engine performance. For additional information, refer to [www.toptiergas.com](http://www.toptiergas.com).

## RUNNING OUT OF FUEL

Avoid running out of fuel because this situation may have an adverse effect on engine components.

If you have run out of fuel:

- You may need to cycle the ignition from off to on several times after refueling to allow the fuel system to pump the fuel from the tank to the engine. On restarting, cranking time will take a few seconds longer than normal. With keyless ignition, just start the engine. Crank time will be longer than usual.
- Normally, adding 1 gal (4 L) of fuel is enough to restart the engine. If the vehicle is out of fuel and on a steep grade, more than 1 gal (4 L) may be required.

## REFUELING

### WARNINGS



Do not overfill the fuel tank. The pressure in an overfilled tank may cause leakage and lead to fuel spray and fire.





Do not remove the fuel pump nozzle from its fully inserted position when refueling.



# Fuel and Refueling

## WARNINGS

 When refueling always shut the engine off and never allow sparks or open flames near the fuel tank filler valve. Never smoke or use a cell phone while refueling. Fuel vapor is extremely hazardous under certain conditions. Avoid inhaling excess fumes.

 Wait at least 10 seconds before removing the fuel pump nozzle to allow any residual fuel to drain into the fuel tank.

 Stop refueling when the fuel pump nozzle automatically shuts off for the first time. Failure to follow this will fill the expansion space in the fuel tank and could lead to fuel overflowing.

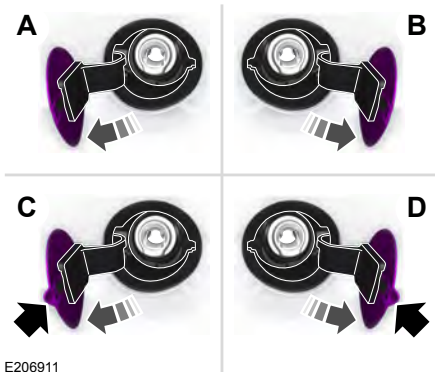

E206911

- A Type 1: Left hand side - press the fuel tank filler door to open it.
- B Type 1: Right hand side - press the fuel tank filler door to open it.
- C Type 2: Left hand side - pull the fuel tank filler door to open it.
- D Type 2: Right hand side - pull the fuel tank filler door to open it.

1. Fully open the fuel tank filler door until it engages.

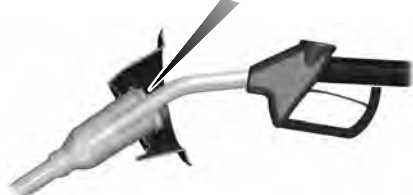
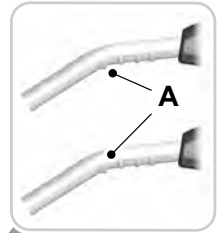

E139202

2. Unlock the fuel filler cap and remove it.
3. Insert the fuel pump nozzle up to the first notch on the nozzle A. Keep it resting on the cover of the fuel tank filler pipe opening.

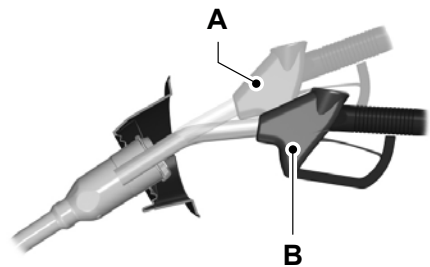

E139203

# Fuel and Refueling

4. Hold the fuel pump nozzle in the lower position B when refueling. Holding the fuel pump nozzle in the higher position A may affect the flow of fuel and shut off the fuel pump nozzle before the fuel tank is full.

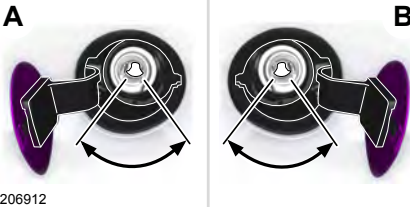

E206912

5. Operate the fuel pump nozzle within the area shown.



E119081

6. Slightly raise the fuel pump nozzle and then slowly remove it.
7. Replace the fuel tank filler cap and close the fuel tank filler door.

**Note:** Do not attempt to start the engine if you have filled the fuel tank with incorrect fuel. Incorrect fuel use can cause damage not covered by the vehicle Warranty. Have your vehicle checked immediately.

## FUEL CONSUMPTION

The advertised capacity is the maximum amount of fuel that you can add to the fuel tank when the fuel gauge indicates empty. In addition, the fuel tank contains an empty reserve. The empty reserve is an unspecified amount of fuel that remains in the fuel tank when the fuel gauge indicates empty.

**Note:** The amount of fuel in the empty reserve varies and should not be relied upon to increase driving range.

## Filling the Fuel Tank

For consistent results when refueling:

- Turn the ignition off before fueling; an inaccurate reading results if the engine is left running.
- Use the same fill rate (low-medium-high) each time the tank is filled.
- Allow no more than one automatic shut-off when refueling.

Results are most accurate when the filling method is consistent.

## Calculating Fuel Economy

Do not measure fuel economy during the first 1,000 mi (1,600 km) of driving (this is your engine's break-in period). A more accurate measurement is obtained after 2,000 mi (3,200 km) to 3,000 mi (4,800 km). Also, fuel expense, frequency of fill ups or fuel gauge readings are not accurate ways to measure fuel economy.

1. Fill the fuel tank completely and record the initial odometer reading.
2. Each time you fill the fuel tank, record the amount of fuel added.
3. After at least three fill ups, fill the fuel tank and record the current odometer reading.

# Fuel and Refueling

---

4. Subtract your initial odometer reading from the current odometer reading.

To calculate L/100 km (liters per 100 kilometers) fuel consumption, multiply the liters used by 100, then divide by kilometers traveled. To calculate MPG (miles per gallon) fuel consumption, divide miles traveled by gallons used.

Keep a record for at least one month and record the type of driving (city or highway). This provides an accurate estimate of your vehicle's fuel economy under current driving conditions. Keeping records during summer and winter will show how temperature impacts fuel economy.

## Conditions

- Heavily loading your vehicle reduces fuel economy.
- Carrying unnecessary weight in your vehicle may reduce fuel economy.
- Adding certain accessories to your vehicle such as bug deflectors, rollbars or light bars, running boards and ski racks may reduce fuel economy.
- Using fuel blended with alcohol may lower fuel economy.
- Fuel economy may decrease with lower temperatures.
- Fuel economy may decrease when driving short distances.
- You will get better fuel economy when driving on flat terrain than when driving on hilly terrain.

# Engine Emission Control

## EMISSION LAW

### WARNING



Do not remove or alter the original equipment floor covering or insulation between it and the metal floor of the vehicle. The floor covering and insulation protect occupants of the vehicle from the engine and exhaust system heat and noise. On vehicles with no original equipment floor covering insulation, do not carry passengers in a manner that permits prolonged skin contact with the metal floor. Failure to follow these instructions may result in fire or personal injury.

U.S. federal laws and certain state laws prohibit removing or rendering inoperative emission control system components. Similar federal or provincial laws may apply in Canada. We do not approve of any vehicle modification without first determining applicable laws.



Tampering with emissions control systems including related sensors or the Diesel Exhaust Fluid system can result in reduced engine power and the illumination of the service engine soon light.

## Tampering With a Noise Control System

Federal laws prohibit the following acts:

- Removal or rendering inoperative by any person other than for purposes of maintenance.
- Repair or replacement of any device or element of the design incorporated into a new vehicle for the purpose of noise control prior to its sale or delivery to the ultimate purchaser or while it is in use.
- The use of the vehicle after any person removes or renders inoperative any device or element of the design.

The U.S. Environmental Protection Agency may presume to constitute tampering as follows:

- Removal of hood blanket, fender apron absorbers, fender apron barriers, underbody noise shields or acoustically absorptive material.
- Tampering or rendering inoperative the engine speed governor, to allow engine speed to exceed manufacturer specifications.

If the engine does not start, runs rough, experiences a decrease in engine performance, experiences excess fuel consumption or produces excessive exhaust smoke, check for the following:

- A plugged or disconnected air inlet system hose.
- A plugged engine air filter element.
- Water in the fuel filter and water separator.
- A clogged fuel filter.
- Contaminated fuel.
- Air in the fuel system, due to loose connections.
- An open or pinched sensor hose.
- Incorrect engine oil level.

# Engine Emission Control

- Incorrect fuel for climatic conditions.
- Incorrect engine oil viscosity for climactic conditions.

**Note:** *Some vehicles have a lifetime fuel filter that is integrated with the fuel tank. Regular maintenance or replacement is not needed.*

**Note:** *If these checks do not help you correct the concern, have your vehicle checked as soon as possible.*

## Noise Emissions Warranty, Prohibited Tampering Acts and Maintenance

On January 1, 1978, Federal regulation became effective governing the noise emission on trucks over 10,000 lb (4,536 kg) Gross Vehicle Weight Rating (GVWR). The preceding statements concerning prohibited tampering acts and maintenance, and the noise warranty found in the Warranty Guide, are applicable to complete chassis cabs over 10,000 lb (4,536 kg) GVWR.

## CATALYTIC CONVERTER

### WARNINGS



Do not park, idle or drive your vehicle on dry grass or other dry ground cover. The emission system heats up the engine compartment and exhaust system, creating the risk of fire.



The normal operating temperature of the exhaust system is very high. Never work around or attempt to repair any part of the exhaust system until it has cooled. Use special care when working around the catalytic converter. The catalytic converter heats up to a very high temperature after only a short period of engine operation and stays hot after the engine is switched off.

### WARNINGS



Exhaust leaks may result in entry of harmful and potentially lethal fumes into the passenger compartment. If you smell exhaust fumes inside your vehicle, have your vehicle inspected immediately. Do not drive if you smell exhaust fumes.

Your vehicle has various emission control components and a catalytic converter that enables it to comply with applicable exhaust emission standards.

To make sure that the catalytic converter and other emission control components continue to work properly:

- Do not crank the engine for more than 10 seconds at a time.
- Do not run the engine with a spark plug lead disconnected.
- Do not push-start or tow-start your vehicle. Use booster cables. See **Jump Starting the Vehicle** (page 57).
- Use only the specified fuel listed.
- Do not switch the ignition off when your vehicle is moving.
- Avoid running out of fuel.
- Have the items listed in scheduled maintenance information performed according to the specified schedule.

**Note:** *Resulting component damage may not be covered by the vehicle Warranty.*

The scheduled maintenance items listed in scheduled maintenance information are essential to the life and performance of your vehicle and to its emissions system.

If you use anything other than Ford, Motorcraft or Ford-authorized parts for maintenance replacements or for service of components affecting emission control, such non-Ford parts should be equivalent to genuine Ford Motor Company parts in performance and durability.

# Engine Emission Control

Illumination of the service engine soon indicator, charging system warning light or the temperature warning light, fluid leaks, strange odors, smoke or loss of engine power could indicate that the emission control system is not working properly.

An improperly operating or damaged exhaust system may allow exhaust to enter the vehicle. Have a damaged or improperly operating exhaust system inspected and repaired immediately.

Do not make any unauthorized changes to your vehicle or engine. By law, vehicle owners and anyone who manufactures, repairs, services, sells, leases, trades vehicles, or supervises a fleet of vehicles are not permitted to intentionally remove an emission control device or prevent it from working. Information about your vehicle's emission system is on the Vehicle Emission Control Information Decal located on or near the engine. This decal also lists engine displacement.

Please consult your warranty information for complete details.

## On-Board Diagnostics (OBD-II)

Your vehicle has a computer known as the on-board diagnostics system (OBD-II) that monitors the engine's emission control system. The system protects the environment by making sure that your vehicle continues to meet government emission standards. The OBD-II system also assists a service technician in properly servicing your vehicle.



When the service engine soon indicator illuminates, the OBD-II system has detected a malfunction. Temporary malfunctions may cause the service engine soon indicator to illuminate. Examples are:

1. Your vehicle has run out of fuel—the engine may misfire or run poorly.
2. Poor fuel quality or water in the fuel—the engine may misfire or run poorly.
3. The fuel fill inlet may not have closed properly. See **Refueling** (page 29).
4. Driving through deep water—the electrical system may be wet.

You can correct these temporary malfunctions by filling the fuel tank with good quality fuel, properly closing the fuel fill inlet or letting the electrical system dry out. After three driving cycles without these or any other temporary malfunctions present, the service engine soon indicator should stay off the next time you start the engine. A driving cycle consists of a cold engine startup followed by mixed city and highway driving. No additional vehicle service is required.

If the service engine soon indicator remains on, have your vehicle serviced at the first available opportunity. Although some malfunctions detected by the OBD-II may not have symptoms that are apparent, continued driving with the service engine soon indicator on can result in increased emissions, lower fuel economy, reduced engine and transmission smoothness and lead to more costly repairs.

## Readiness for Inspection and Maintenance (I/M) Testing

Some state and provincial and local governments may have Inspection/Maintenance (I/M) programs to inspect the emission control equipment on your vehicle. Failure to pass this inspection could prevent you from getting a vehicle registration.



If the service engine soon indicator is on or the bulb does not work, your vehicle may need service. See On-Board Diagnostics.

# Engine Emission Control

---

Your vehicle may not pass the I/M test if the service engine soon indicator is on or not working properly (bulb is burned out), or if the OBD-II system has determined that some of the emission control systems have not been properly checked. In this case, the vehicle is not ready for I/M testing.

If the vehicle's engine or transmission has just been serviced, or the battery has recently run down or been replaced, the OBD-II system may indicate that the vehicle is not ready for I/M testing. To determine if the vehicle is ready for I/M testing, turn the ignition key to the on position for 15 seconds without cranking the engine. If the service engine soon indicator blinks eight times, it means that the vehicle is not ready for I/M testing; if the service engine soon indicator stays on solid, it means that your vehicle is ready for I/M testing.

The OBD-II system checks the emission control system during normal driving. A complete check may take several days.

If the vehicle is not ready for I/M testing, you can perform the following driving cycle consisting of mixed city and highway driving:

1. 15 minutes of steady driving on an expressway or highway followed by 20 minutes of stop-and-go driving with at least four 30-second idle periods.
2. Allow your vehicle to sit for at least eight hours with the ignition off. Then, start the vehicle and complete the above driving cycle. The vehicle must warm up to its normal operating temperature. Once started, do not turn off the vehicle until the above driving cycle is complete.

If the vehicle is still not ready for I/M testing, you need to repeat the above driving cycle.

# Transmission

## AUTOMATIC TRANSMISSION

### WARNINGS



Always set the parking brake fully and latch the gearshift in park (P). Turn the ignition to the off position and remove the key whenever you leave your vehicle.



Do not apply the brake pedal and accelerator pedal simultaneously. Applying both pedals simultaneously for more than three seconds will limit engine rpm, which may result in difficulty maintaining speed in traffic and could lead to serious injury.

## Understanding the Positions of Your Automatic Transmission

P R N D 3 2 1

E161511

### Putting your vehicle in or out of gear:

1. Fully press down the brake pedal.
2. Move the gearshift lever into the desired gear.
3. Come to a complete stop.
4. Move the gearshift lever and securely latch it in park (P)

### Park (P)

This position locks the transmission and prevents the wheels from turning.

### Reverse (R)

With the gearshift lever in reverse (R), your vehicle will move backward. Always come to a complete stop before shifting into and out of reverse (R).

### Neutral (N)

With the gearshift lever in neutral (N), your vehicle can be started and is free to roll. Hold the brake pedal down while in this position.

### Drive (D)

Drive (D) is the normal driving position for the best fuel economy. The overdrive function allows automatic upshifts through all available gears.

### Third (3)

Transmission operates in third (3) gear only. Use third (3) gear for improved traction on slippery roads.

### Second (2)

Transmission operates in second (2) gear only. Use second (2) gear to start-up on slippery roads.

### First (1)

- Transmission operates in first (1) gear only.
- Provides maximum engine braking.
- Allows upshifts by moving gearshift lever.
- Will not downshift into first (1) gear at high speeds; allows for first (1) gear when vehicle reaches slower speeds.



# Transmission

## Tow/Haul Mode

### WARNING



Do not use the tow/haul feature when driving in icy or slippery conditions as the increased engine braking can cause the wheels to slide and your vehicle to swing around with the possible loss of vehicle control.



E161510



To activate tow/haul, press the button on the gearshift lever once. The TOW HAUL indicator light will illuminate in the instrument cluster.

To deactivate the tow/haul feature and return to normal driving mode, press the button on the gearshift lever again. The TOW HAUL light will deactivate. Tow/haul will also deactivate when your power down your vehicle.

The tow/haul feature:

- Delays upshifts to reduce the frequency of transmission shifting.
- Provides engine braking in all forward gears, which will slow your vehicle and assist you in controlling your vehicle when descending a grade.
- Depending on driving conditions and load conditions, may downshift the transmission, slow your vehicle and control your vehicle speed when descending a hill, without pressing the accelerator pedal. The amount of downshift braking provided will vary based upon the amount the brake pedal is pressed.

The tow/haul feature improves transmission operation when towing a trailer or a heavy load. All transmission gear ranges are available when using tow/haul.

## Automatic Transmission Adaptive Learning

This feature may increase durability and provide consistent shift feel over the life of your vehicle. A new vehicle or transmission may have firm shifts, soft shifts or both. This operation is considered normal and will not affect function or durability of the transmission. Over time, the adaptive learning process will fully update transmission operation.

## Forced Downshifts

- Allowed in drive (D) with the tow/haul feature on or off.
- Press the accelerator pedal to the floor.
- Allows transmission to select an appropriate gear.

# Transmission

## Brake-Shift Interlock

### WARNINGS



Do not drive your vehicle until you verify that the brake lamps are working.



If your brake lamps are not working properly or if you have disconnected the vehicle battery cables, the vehicle brake lamps and hazard flashers may not properly warn traffic of a vehicle breakdown or approaching danger, which can increase the risk of serious injury or death. To minimize the risk of serious injury or death, be aware of your surroundings, use other hazard signaling devices if available, and move the vehicle to a safe location away from traffic as soon as possible.



When doing this procedure, you will be taking the vehicle out of park which means the vehicle can roll freely. To avoid unwanted vehicle movement, always fully set the parking brake prior to doing this procedure. Use wheel chocks if appropriate.



If the parking brake is fully released, but the brake warning lamp remains illuminated, the brakes may not be working properly. See your authorized dealer.

Your vehicle is equipped with a brake-shift interlock feature that prevents moving the gearshift lever from park (P) when the ignition is in the on position and the brake pedal is not pressed.

If you cannot move the gearshift lever out of park (P) position with the ignition in the on position and the brake pedal pressed, a malfunction may have occurred. It is possible that a fuse has blown or your vehicle's brake lamps are not operating properly. See **Fuse Specification Chart** (page 68).

If the fuse is not blown and the brake lamps are working properly, the following procedure will allow you to move the gearshift lever from park (P):

1. Apply the parking brake. Turn key to the lock position, and then remove the key.
2. Disconnect the negative (black) battery cable from the battery.
3. Insert the key and turn to the off position. Shift the transmission to neutral (N).
4. Reconnect the negative (black) battery cable to the battery.
5. Start the vehicle.

**Note:** See your authorized dealer as soon as possible if this procedure is used.

### If Your Vehicle Gets Stuck In Mud or Snow

**Note:** Do not rock your vehicle if the engine is not at normal operating temperature or damage to the transmission may occur.

**Note:** Do not rock your vehicle for more than a minute or damage to the transmission and tires may occur, or the engine may overheat.

If your vehicle gets stuck in mud or snow, you may rock it out by shifting between forward and reverse gears, stopping between shifts in a steady pattern. Press lightly on the accelerator in each gear.

# Brakes

## GENERAL INFORMATION

**Note:** Occasional brake noise is normal. If a metal-to-metal, continuous grinding or continuous squeal sound is present, the brake linings may be worn-out and should be inspected by an authorized dealer. If the vehicle has continuous vibration or shudder in the steering wheel while braking, the vehicle should be inspected by an authorized dealer.

**Note:** Brake dust may accumulate on the wheels, even under normal driving conditions. Some dust is inevitable as the brakes wear and does not contribute to brake noise. See **Cleaning the Wheels** (page 106).



See the Instrument Cluster chapter for information on the brake system warning light.

Wet brakes result in reduced braking efficiency. Gently press the brake pedal a few times when driving from a car wash or standing water to dry the brakes.

### Brake Over Accelerator

In the event the accelerator pedal becomes stuck or entrapped, apply steady and firm pressure to the brake pedal to slow the vehicle and reduce engine power. If you experience this condition, apply the brakes and bring your vehicle to a safe stop. Turn the engine off, shift the transmission into park (P), apply the parking brake, and then inspect the accelerator pedal for any interferences. If none are found and the condition persists, have your vehicle towed to the nearest authorized dealer.

### Hydraulic brake booster system (Hydroboost or Hydromax)

The Hydroboost and Hydromax systems receive fluid pressure from the power steering pump to provide power assist during braking.

The Hydromax booster receives backup pressure from the reserve system electric pump whenever the fluid in the power steering system is not flowing. When the engine is off, the pump will turn on if the brake pedal is applied, or if the ignition is turned to the on position.

The sound of the pump operating may be heard by the driver, but this is a normal characteristic of the system.

The reserve system provides reduced braking power, so the vehicle should be operated under these conditions with caution, and only to seek service repair and remove the vehicle from the roadway.

**Note:** For Hydromax-equipped vehicles operating under normal conditions, the noise of the fluid flowing through the booster may be heard whenever the brake is applied. This condition is normal. Vehicle service is not required.

If braking performance or pedal response becomes very poor, even when the pedal is strongly pressed, it may indicate the presence of air in the hydraulic system or leakage of fluid. Stop the vehicle safely as soon as possible and seek service immediately.

## HINTS ON DRIVING WITH ANTI-LOCK BRAKES

The anti-lock braking system does not eliminate the risks when:

- You drive too closely to the vehicle in front of you.
- Your vehicle is hydroplaning.

# Brakes

---

- You take corners too fast.
- The road surface is poor.

**Note:** *If the system activates, the brake pedal may pulse and may travel further. Maintain pressure on the brake pedal. You may also hear a noise from the system. This is normal.*

To release the parking brake:

- For vehicles equipped with a foot operated parking brake, pull the parking brake release lever.
- For vehicles equipped with a hand operated parking brake, push the parking brake lever down.

## PARKING BRAKE

### WARNING



Always set the parking brake fully and make sure the transmission selector lever is placed in park (P).

Failure to set the parking brake and engage park could result in vehicle roll-away, property damage or bodily injury. Turn the ignition to the lock position and remove the key whenever you leave your vehicle.

Apply the parking brake whenever your vehicle is parked.

- For vehicles equipped with a foot operated parking brake, press the pedal downward to set the parking brake.
- For vehicle equipped with a hand operated parking brake, pull the parking brake lever up to set the parking brake.



The brake warning lamp in the instrument cluster illuminates when the ignition is turned on and the parking brake is applied.

The parking brake is not recommended to stop a moving vehicle. However, if the normal brakes fail, the parking brake can be used to stop your vehicle in an emergency. Your vehicle's stopping distance will increase greatly and the handling of your vehicle will be adversely affected.

# Cruise Control

## PRINCIPLE OF OPERATION

Cruise control lets you maintain a set speed without keeping your foot on the accelerator pedal. You can use cruise control when your vehicle speed is greater than 20 mph (30 km/h).

## USING CRUISE CONTROL

### WARNINGS



Do not use cruise control on winding roads, in heavy traffic or when the road surface is slippery. This could result in loss of vehicle control, serious injury or death.



When you are going downhill, your vehicle speed could increase above the set speed. The system does not apply the brakes.

To help the system to maintain the set speed when going downhill, downshift to a lower gear.



E161518

The cruise controls are on the steering wheel.

## Switching Cruise Control On

Press **ON**.



The indicator appears in the information display.

## Setting the Cruise Speed

1. Drive to desired speed.
2. Press **SET ACCEL**.
3. Take your foot off the accelerator pedal.

## Changing the Set Speed

- Press the accelerator or brake pedal until you reach the desired speed. Press **SET ACCEL**.
- Press **SET ACCEL** to change the set speed in small increments.
- Press and hold **SET ACCEL**. Release the control when you reach the desired speed.

## Canceling the Set Speed

Press **COAST** or tap the brake pedal. The set speed does not erase.

## Resuming the Set Speed

Press **RES**.

## Switching Cruise Control Off

**Note:** You erase the set speed when you switch the system off.

Press **OFF** when the system is in standby mode, or switch the ignition off.

# Load Carrying

## LOAD LIMIT

### Vehicle Loading - with and without a Trailer

This section guides you in the proper loading of your vehicle, trailer, or both. Keep your loaded vehicle weight within its design rating capability, with or without a trailer. Properly loading your vehicle provides maximum return of vehicle design performance. Before you load your vehicle, become familiar with the following terms for determining your vehicle's weight rating, with or without a trailer, from the vehicle's Tire and Loading Information label or Safety Compliance Certification label.

### Tire and Loading Label Information Example:

**TIRE AND LOADING INFORMATION**

SEATING CAPACITY TOTAL: 5 FRONT: 2 REAR: 3

The combined weight of occupants and cargo should never exceed: **385 kg or 850 lbs.**

TIRE	SIZE	COLD TIRE PRESSURE	SEE OWNERS MANUAL FOR ADDITIONAL INFORMATION
FRONT	235/45R18 94V	235 KPA, 34 PSI	
REAR	235/45R18 94V	235 KPA, 34 PSI	
SPARE	NONE	NONE	

**TIRE AND LOADING INFORMATION**  
**RENSEIGNEMENTS SUR LES PNEUS ET LE CHARGEMENT**

SEATING CAPACITY / NOMBRE DE PLACES TOTAL 5 FRONT AVANT 2 REAR ARRIERE 3

The combined weight of occupants and cargo should never exceed 396 kg or 875 lbs.  
Le poids total des occupants et du chargement ne doit jamais dépasser

TIRE / PNEU	SIZE / DIMENSIONS	COLD TIRE PRESSURE / PRESSION DES PNEUS A FROID	SEE OWNER'S MANUAL FOR ADDITIONAL INFORMATION VOIR LE MANUEL DE L'USAGER POUR PLUS DE RENSEIGNEMENTS
FRONT AVANT	235/40R19 96V	255 KPA, 37 PSI	
REAR ARRIERE	235/40R19 96V	255 KPA, 37 PSI	
SPARE DE SECOURS	T125/80R16 97M	415 KPA, 60 PSI	

E198719

## Payload

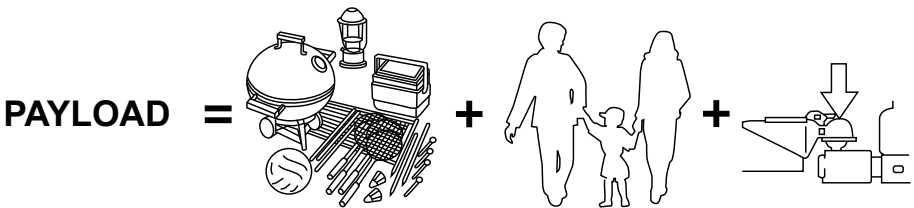

E143816

# Load Carrying

---

Payload is the combined weight of cargo and passengers that your vehicle is carrying. The maximum payload for your vehicle appears on the Tire and Loading label. The label is either on the B-pillar or the edge of the driver door. Vehicles exported outside the US and Canada may not have a tire and loading label. Look for “The combined weight of occupants and cargo should never exceed XXX kg OR XXX lb” for maximum payload. The payload listed on the Tire and Loading Information label is the maximum payload for your vehicle as built by the assembly plant. If you install any additional equipment on your vehicle, you must determine the new payload. Subtract the weight of the equipment from the payload listed on the Tire and Loading label. When towing, trailer tongue weight or king pin weight is also part of payload.

## **WARNING**



The appropriate loading capacity of your vehicle can be limited either by volume capacity (how much space is available) or by payload capacity (how much weight the vehicle should carry). Once you have reached the maximum payload of your vehicle, do not add more cargo, even if there is space available. Overloading or improperly loading your vehicle can contribute to loss of vehicle control and vehicle rollover.

---

## **GAWR (Gross Axle Weight Rating)**

GAWR is the maximum allowable weight that a single axle (front or rear) can carry. These numbers are on the Safety Compliance Certification label. The label is located on the door hinge pillar, door-latch post, or the door edge that meets the door-latch post, next to the driver seating position.

The total load on each axle must never exceed its Gross Axle Weight Rating.

## **GVWR (Gross Vehicle Weight Rating)**

GVWR is the maximum allowable weight of the fully loaded vehicle. This includes all options, equipment, passengers and cargo. It appears on the Safety Compliance Certification label. The label is located on the door hinge pillar, door-latch post, or the door edge that meets the door-latch post, next to the driver seating position.

The gross vehicle weight must never exceed the Gross Vehicle Weight Rating.

# Load Carrying

## Safety Compliance Certification Label Example:

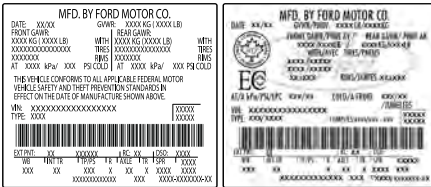

E108628

## WARNING



Exceeding the Safety Compliance Certification label vehicle weight limits can adversely affect the performance and handling of your vehicle, cause vehicle damage and can result in the loss of control of your vehicle, serious personal injury or death.

## Maximum Loaded Trailer Weight

Maximum loaded trailer weight is the highest possible weight of a fully loaded trailer the vehicle can tow. Consult an authorized dealer (or the RV and Trailer Towing Guide available at an authorized dealer) for more detailed information.

## GCWR (Gross Combined Weight Rating)

GCWR is the maximum allowable weight of the vehicle and the loaded trailer, including all cargo and passengers, that the vehicle can handle without risking damage. (Important: The towing vehicle's braking system is rated for operation at Gross Vehicle Weight Rating, not at Gross Combined Weight Rating.) Separate functional brakes should be used for safe control of towed vehicles and for trailers where the Gross Combined Weight of the towing vehicle plus the trailer exceed the Gross Vehicle Weight Rating of the towing vehicle.

The gross combined weight must never exceed the Gross Combined Weight Rating.

**Note:** For trailer towing information refer to the *RV and Trailer Towing Guide* available at an authorized dealer.

## WARNINGS



Do not exceed the GVWR or the GAWR specified on the certification label.



Do not use replacement tires with lower load carrying capacities than the original tires because they may lower your vehicle's GVWR and GAWR limitations. Replacement tires with a higher limit than the original tires do not increase the GVWR and GAWR limitations.



# Load Carrying

## WARNINGS



Exceeding any vehicle weight rating can adversely affect the performance and handling of your vehicle, cause vehicle damage and can result in the loss of control of your vehicle, serious personal injury or death.

### Steps for determining the correct load limit:

1. Locate the statement "The combined weight of occupants and cargo should never exceed XXX kg or XXX lb." on your vehicle's placard.
2. Determine the combined weight of the driver and passengers that will be riding in your vehicle.
3. Subtract the combined weight of the driver and passengers from XXX kg or XXX lb.
4. The resulting figure equals the available amount of cargo and luggage load capacity. For example, if the "XXX" amount equals 1,400 lb. and there will be five 150 lb. passengers in your vehicle, the amount of available cargo and luggage load capacity is 650 lb.  $(1400 - 750 (5 \times 150) = 650 \text{ lb.})$
5. Determine the combined weight of luggage and cargo being loaded on the vehicle. That weight may not safely exceed the available cargo and luggage load capacity calculated in Step 4.
6. If your vehicle will be towing a trailer, load from your trailer will be transferred to your vehicle. Consult this manual to determine how this reduces the available cargo and luggage load capacity of your vehicle.

### ***Helpful examples for calculating the available amount of cargo and luggage load capacity***

Suppose your vehicle has a 1400-pound (635-kilogram) cargo and luggage capacity. You decide to go golfing. Is there enough load capacity to carry you, four of your friends and all the golf bags? You and four friends average 220 pounds (99 kilograms) each and the golf bags weigh approximately 30 pounds (13.5 kilograms) each. The calculation would be:  $1400 - (5 \times 220) - (5 \times 30) = 1400 - 1100 - 150 = 150$  pounds. Yes, you have enough load capacity in your vehicle to transport four friends and your golf bags. In metric units, the calculation would be:  $635 \text{ kilograms} - (5 \times 99 \text{ kilograms}) - (5 \times 13.5 \text{ kilograms}) = 635 - 495 - 67.5 = 72.5$  kilograms.

# Load Carrying

Suppose your vehicle has a 1400-pound (635-kilogram) cargo and luggage capacity. You and one of your friends decide to pick up cement from the local home improvement store to finish that patio you have been planning for the past two years. Measuring the inside of the vehicle with the rear seat folded down, you have room for twelve 100-pound (45-kilogram) bags of cement. Do you have enough load capacity to transport the cement to your home? If you and your friend each weigh 220 pounds (99 kilograms), the calculation would be:  $1400 - (2 \times 220) - (12 \times 100) = 1400 - 440 - 1200 = -240$  pounds. No, you do not have enough cargo capacity to carry that much weight. In metric units, the calculation would be:  $635 \text{ kilograms} - (2 \times 99 \text{ kilograms}) - (12 \times 45 \text{ kilograms}) = 635 - 198 - 540 = -103$  kilograms. You will need to reduce the load weight by at least 240 pounds (104 kilograms). If you remove three 100-pound (45-kilogram) cement bags, then the load calculation would be:  $1400 - (2 \times 220) - (9 \times 100) = 1400 - 440 - 900 = 60$  pounds. Now you have the load capacity to transport the cement and your friend home. In metric units, the calculation would be:  $635 \text{ kilograms} - (2 \times 99 \text{ kilograms}) - (9 \times 45 \text{ kilograms}) = 635 - 198 - 405 = 32$  kilograms.

The above calculations also assume that the loads are positioned in your vehicle in a manner that does not overload the front or the rear gross axle weight rating specified for your vehicle on the Safety Compliance Certification label.

## Special Loading Instructions for Owners of Pick-up Trucks and Utility-type Vehicles

### WARNING



When loading the roof racks, we recommend you evenly distribute the load, as well as maintain a low center of gravity. Loaded vehicles, with higher centers of gravity, may handle differently than unloaded vehicles. Take extra precautions, such as slower speeds and increased stopping distance, when driving a heavily loaded vehicle.

# Towing

---

## TOWING A TRAILER

### WARNINGS



Towing trailers beyond the maximum recommended gross trailer weight exceeds the limit of your vehicle and could result in engine damage, transmission damage, structural damage, loss of vehicle control, vehicle rollover and personal injury.



Do not exceed the GVWR or the GAWR specified on the certification label.

---

**Note:** See **Recommended Towing Weights** (page 49).

Your vehicle may have electrical items, such as fuses or relays, related to towing. See **Fuses** (page 68).

Your vehicle's load capacity designation is by weight, not by volume, so you cannot necessarily use all available space when loading a vehicle or trailer.

Towing a trailer places an extra load on your vehicle's engine, transmission, axle, brakes, tires and suspension. Inspect these components periodically during, and after, any towing operation.

## Load Placement

To help minimize how trailer movement affects your vehicle when driving:

- Load the heaviest items closest to the trailer floor.
- Load the heaviest items centered between the left and right side trailer tires.
- Load the heaviest items above the trailer axles or just slightly forward toward the trailer tongue. Do not allow the final trailer tongue weight to go above or below 10-15% of the loaded trailer weight.
- Select a ball mount with the correct rise or drop and load capacity. When both the loaded vehicle and trailer are connected, the trailer frame should be level, or slightly angled down toward your vehicle, when viewed from the side.

When driving with a trailer or payload, a slight takeoff vibration or shudder may be present due to the increased payload weight. Additional information regarding proper trailer loading and setting your vehicle up for towing is located in another chapter of this manual. See **Load Limit** (page 43).

You can also find information in the **RV & Trailer Towing Guide** available at your authorized dealer, or online.

# Towing

## RV & Trailer Towing Guide Online

Website | <http://www.fleet.ford.com/towing-guides/>

### RECOMMENDED TOWING WEIGHTS

**Note:** Do not exceed the trailer weight for your vehicle configuration listed in the chart below.

**Note:** Make sure to take into consideration trailer frontal area. Do not exceed 60 feet<sup>2</sup> (5.6 meters<sup>2</sup>) trailer frontal area.

**Note:** For high altitude operation, reduce the gross combined weight by 2% per 1000 feet (300 meters) starting at the 1000 foot (300 meter) elevation point.

**Note:** Certain states require electric trailer brakes for trailers over a specified weight. Be sure to check state regulations for this specified weight. The maximum trailer weights listed may be limited to this specified weight, as the vehicle's electrical system may not include the wiring connector needed to activate electric trailer brakes.

Your vehicle may tow a trailer provided the maximum trailer weight is less than or equal to the maximum trailer weight listed for your vehicle configuration on the following chart.

Rear axle ratio	Maximum GVWR	Maximum GCWR	Maximum trailer weight
4.30	16000 lb (7257 kg)	23000 lb (10432 kg)	7000 lb (3175 kg)
4.30	18000 lb (8165 kg)	23000 lb (10432 kg)	5000 lb (2268 kg)
4.88	19500 lb (8845 kg)	26000 lb (11793 kg)	6500 lb (2948 kg)
4.88	19500 lb (8845 kg)	27200 lb (12338 kg)	7700 lb (3493 kg)
5.38	20500 lb (9299 kg)	26000 lb (11793 kg)	5500 lb (2495 kg)

## Towing

<b>Rear axle ratio</b>	<b>Maximum GVWR</b>	<b>Maximum GCWR</b>	<b>Maximum trailer weight</b>
5.38	22000 lb (9979 kg)	26000 lb (11793 kg)	4000 lb (1814 kg)
5.38	22000 lb (9979 kg)	26000 lb (11793 kg)	6500 lb (2948 kg)
5.38	22000 lb (9979 kg)	29700 lb (13472 kg)	7700 lb (3493 kg)
6.17	24000 lb (10886 kg)	30000 lb (13608 kg)	6000 lb (2721 kg)
6.17	26000 lb (11793 kg)	30000 lb (13608 kg)	4000 lb (1814 kg)

# Towing

## ESSENTIAL TOWING CHECKS

Follow these guidelines for safe towing:

- Do not tow a trailer until you drive your vehicle at least 1,000 mi (1,600 km).
- Consult your local motor vehicle laws for towing a trailer.
- See the instructions included with towing accessories for the proper installation and adjustment specifications.
- Service your vehicle more frequently if you tow a trailer. See your scheduled maintenance information.
- If you use a rental trailer, follow the instructions the rental agency gives you.

Another chapter of this manual contains load specification terms found on the tire label and Safety Compliance label and instructions on calculating your vehicle's load. See **Load Limit** (page 43).

Remember to account for the trailer tongue weight as part of your vehicle load when calculating the total vehicle weight.

## Hitches

Do not use a hitch that either clamps onto the bumper or attaches to the axle.

Distribute the trailer load so 10-15% of the total trailer weight is on the tongue.

## Weight-Distributing Hitches

### WARNING



Do not adjust a weight-distributing hitch to any position where the rear bumper of the vehicle is higher than it was before attaching the trailer. Doing so will defeat the function of the weight-distributing hitch, which may cause unpredictable handling, and could result in serious personal injury.

When hooking-up a trailer using a weight-distributing hitch, always use the following procedure:

1. Park the loaded vehicle, without the trailer, on a level surface.
2. Measure the height to the top of your vehicle's front wheel opening on the fender. This is H1.
3. Securely attach the loaded trailer to your vehicle without the weight-distributing bars connected.
4. Measure the height to the top of your vehicle's front wheel opening on the fender a second time. This is H2.
5. Install and adjust the tension in the weight-distributing bars so that the height of your vehicle's front wheel opening on the fender is approximately halfway between H1 and H2.
6. Check that the trailer is level or slightly nose down toward your vehicle. If not, adjust the ball height accordingly and repeat Steps 1-6.
7. Lock the bar tension adjuster in place.
8. Check that the trailer tongue securely attaches and locks onto the hitch.
9. Install safety chains, lighting and trailer brake controls as required by law or the trailer manufacturer.

## Safety Chains

**Note:** *Never attach safety chains to the bumper.*

Always connect the safety chains to the hook retainers of your vehicle hitch.

To connect the safety chains, cross them under the trailer tongue and allow enough slack for turning tight corners. Do not allow the chains to drag on the ground.

# Towing

## Trailer Brakes

### WARNING



Do not connect a trailer's hydraulic brake system directly to your vehicle's brake system. Your vehicle may not have enough braking power and your chances of having a collision greatly increase.

Electric brakes and manual, automatic or surge-type trailer brakes are safe if you install them properly and adjust them to the manufacturer's specifications. The trailer brakes must meet local and federal regulations.

**The rating for the tow vehicle's braking system operation is at the gross vehicle weight rating, not the gross combined weight rating.**

**Separate functioning brake systems are required for safe control of towed vehicles and trailers weighing more than 1500 pounds (680 kilograms) when loaded.**

## Trailer Lamps

### WARNING



Never connect any trailer lamp wiring to the vehicle's tail lamp wiring; this may damage the electrical system resulting in fire. Contact your authorized dealer as soon as possible for assistance in proper trailer tow wiring installation. Additional electrical equipment may be required.

Trailer lamps are required on most towed vehicles. Make sure all running lights, brake lights, direction indicators and hazard lights are working.

## Before Towing a Trailer

Practice turning, stopping and backing up to get the feel of your vehicle-trailer combination before starting on a trip. When turning, make wider turns so the trailer wheels clear curbs and other obstacles.

## When Towing a Trailer

- Do not drive faster than 70 mph (113 km/h) during the first 500 mi (800 km).
- Do not make full-throttle starts.
- Check your hitch, electrical connections and trailer wheel lug nuts thoroughly after you have traveled 50 mi (80 km).
- When stopped in congested or heavy traffic during hot weather, place the gearshift in park (P) to aid engine and transmission cooling and to help air conditioning performance.
- Switch off the speed control with heavy loads or in hilly terrain. The speed control may turn off automatically when you are towing on long, steep grades.
- Shift to a lower gear when driving down a long or steep hill. Do not apply the brakes continuously, as they may overheat and become less effective.
- If your transmission is equipped with a Grade Assist or Tow/Haul feature, use this feature when towing. This provides engine braking and helps eliminate excessive transmission shifting for optimum fuel economy and transmission cooling.
- Allow more distance for stopping with a trailer attached. Anticipate stops and brake gradually.
- Avoid parking on a grade. However, if you must park on a grade:
  1. Turn the steering wheel to point your vehicle tires away from traffic flow.

# Towing

2. Set your vehicle parking brake.
3. Place the automatic transmission in park (P).
4. Place wheel chocks in the front and back of the trailer wheels. (Chocks not included with vehicle.)

## Launching or Retrieving a Boat or Personal Watercraft (PWC)

**Note:** *Disconnect the wiring to the trailer before backing the trailer into the water.*

**Note:** *Reconnect the wiring to the trailer after removing the trailer from the water.*

When backing down a ramp during boat launching or retrieval:

- Do not allow the static water level to rise above the bottom edge of the rear bumper.
- Do not allow waves to break higher than 6 in (15 cm) above the bottom edge of the rear bumper.

Exceeding these limits may allow water to enter vehicle components:

- Causing internal damage to the components.
- Affecting driveability, emissions and reliability.

Replace the rear axle lubricant anytime the rear axle has been submerged in water. Water may have contaminated the rear axle lubricant, which is not normally checked or changed unless a leak is suspected or other axle repair is required.

## TOWING THE VEHICLE ON FOUR WHEELS

### Emergency Towing

#### WARNING



If your vehicle has a steering wheel lock make sure the ignition is in the accessory or on position when being towed.

If your vehicle becomes inoperable (without access to wheel dollies, car-hauling trailer, or flatbed transport vehicle), it can be flat-towed (all wheels on the ground, regardless of the powertrain and transmission configuration) under the following conditions:

- Your vehicle is facing forward for towing in a forward direction.
- Place the transmission in position **N**. If you cannot move the transmission into **N**, you may need to override it.
- Maximum speed is 35 mph (56 km/h).
- Maximum distance is 50 mi (80 km).



# Driving Hints

## BREAKING-IN

You need to break in new tires for approximately 300 mi (480 km). During this time, your vehicle may exhibit some unusual driving characteristics.

Avoid driving too fast during the first 1,000 mi (1,600 km). Vary your speed frequently and change up through the gears early. Do not labor the engine.

Do not tow during the first 1,000 mi (1,600 km).

## REDUCED ENGINE PERFORMANCE

### WARNING



If you continue to drive your vehicle when the engine is overheating, the engine could stop without warning.

Failure to follow this instruction could result in the loss of control of your vehicle.

If the engine coolant temperature gauge needle moves to the upper limit position, the engine is overheating. See **Gauges** (page 16).

You must only drive your vehicle for a short distance if the engine overheats. The distance you can travel depends on ambient temperature, vehicle load and terrain. The engine continues to operate with limited power for a short period of time.

If the engine temperature continues to rise, the fuel supply to the engine reduces. The air conditioning switches off and the engine cooling fan operates continually.

1. Gradually reduce your speed and stop your vehicle as soon as it is safe to do so.
2. Immediately switch the engine off to prevent severe engine damage.

3. Wait for the engine to cool down.
4. Check the coolant level. See **Engine Coolant Check** (page 93).
5. Have your vehicle checked as soon as possible.

## ECONOMICAL DRIVING

Your fuel economy is affected by several things, such as how you drive, the conditions you drive under, and how you maintain your vehicle.

You may improve your fuel economy by keeping these things in mind:

- Accelerate and slow down in a smooth, moderate fashion.
- Drive at steady speeds without stopping.
- Anticipate stops; slowing down may eliminate the need to stop.
- Combine errands and minimize stop-and-go driving.
- Close the windows for high-speed driving.
- Drive at reasonable speeds (traveling at 55 mph [88 km/h] uses 15% less fuel than traveling at 65 mph [105 km/h]).
- Keep the tires properly inflated and use only the recommended size.
- Use the recommended engine oil.
- Perform all regularly scheduled maintenance.

Avoid these actions; they reduce your fuel economy:

- Sudden accelerations or hard accelerations.
- Revving the engine before turning it off.
- Idle for periods longer than one minute.
- Warm up your vehicle on cold mornings.

# Driving Hints

- Use the air conditioner or front defroster.
- Use the speed control in hilly terrain.
- Rest your foot on the brake pedal while driving.
- Drive a heavily loaded vehicle or tow a trailer.
- Carry unnecessary weight (approximately 1 mpg [0.4 km/L] is lost for every 400 lb [180 kilogram] of weight carried).
- Driving with the wheels out of alignment.

## Conditions

- Heavily loading a vehicle or towing a trailer may reduce fuel economy at any speed.
- Adding certain accessories to your vehicle (for example bug deflectors, rollbars, light bars, running boards, ski racks or luggage racks) may reduce fuel economy.
- To maximize the fuel economy, drive with the tonneau cover installed (if equipped).
- Using fuel blended with alcohol may lower fuel economy.
- Fuel economy may decrease with lower temperatures during the first 5–10 mi (12–16 km) of driving.
- Driving on flat terrain offers improved fuel economy as compared to driving on hilly terrain.
- Transmissions give their best fuel economy when operated in the top cruise gear and with steady pressure on the gas pedal.
- Four-wheel-drive operation (if equipped) is less fuel efficient than two-wheel-drive operation.
- Close the windows for high-speed driving.

## DRIVING THROUGH WATER

### WARNING



Do not drive through flowing or deep water as you may lose control of your vehicle.

**Note:** *Driving through standing water can cause vehicle damage.*

**Note:** *Engine damage can occur if water enters the air filter.*

Before driving through standing water, check the depth. Never drive through water that is higher than the bottom of the wheel hubs.

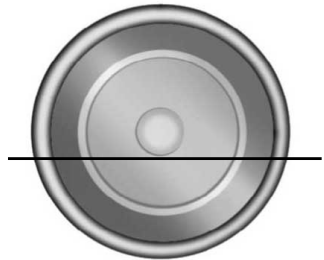

E176913

When driving through standing water, drive very slowly and do not stop your vehicle. Your brake performance and traction may be limited. After driving through water and as soon as it is safe to do so:

- Lightly press the brake pedal to dry the brakes and to check that they work.
- Check that the horn works.
- Check that the exterior lights work.
- Turn the steering wheel to check that the steering power assist works.

# Roadside Emergencies

---

## ROADSIDE ASSISTANCE

### Vehicles Sold in the United States: Getting Roadside Assistance

To fully assist you should you have a vehicle concern, Ford Motor Company offers a complimentary roadside assistance program. This program is separate from the New Vehicle Limited Warranty.

The service is available:

- 24 hours a day, seven days a week.
- For the coverage period listed on the Roadside Assistance Card included in your Owner's Manual portfolio.

Roadside Assistance covers:

- A flat tire change with a good spare (except vehicles supplied with a tire inflation kit).
- Battery jump start.
- Lock-out assistance (key replacement cost is the customer's responsibility).
- Fuel delivery — independent service contractors, if not prohibited by state, local or municipal law, shall deliver up to 2 gal (8 L) of gasoline or 5 gal (20 L) of diesel fuel to a disabled vehicle. Roadside Assistance limits fuel delivery service to two no-charge occurrences within a 12-month period.
- Winch out — available within 100 ft (30 m) of a paved or county maintained road, no recoveries.

- Towing — independent service contractors, if not prohibited by state, local or municipal law, shall tow Ford eligible vehicles to an authorized dealer within 35 mi (56 km) of the disablement location or to the nearest authorized dealer. If a member requests a tow to an authorized dealer that is more than 35 mi (56 km) from the disablement location, the member shall be responsible for any mileage costs in excess of 35 mi (56 km).
- Roadside Assistance includes up to \$200 for a towed trailer if the disabled eligible vehicle requires service at the nearest authorized dealer. If the towing vehicle is operational but the trailer is not, then the trailer does not qualify for any roadside services.

### Vehicles Sold in the United States: Using Roadside Assistance

Complete the roadside assistance identification card and place it in your wallet for quick reference. This card is in the owner's information portfolio in the glove compartment.

United States vehicle customers who require Roadside Assistance, call 1-800-241-3673.

If you need to arrange roadside assistance for yourself, Ford Motor Company reimburses a reasonable amount for towing to the nearest dealership within 35 mi (56 km). To obtain reimbursement information, United States vehicle customers call 1-800-241-3673. Customers need to submit their original receipts.

# Roadside Emergencies

## Vehicles Sold in Canada: Getting Roadside Assistance

To fully assist you should you have a vehicle concern, Ford Motor Company of Canada, Limited offers a complimentary roadside assistance program. This program is eligible within Canada or the continental United States.

This program is separate from the New Vehicle Limited Warranty, but the coverage is concurrent with the powertrain coverage period of your vehicle.

Canadian customers who require roadside assistance, call 1-800-665-2006.

## Vehicles Sold in Canada: Using Roadside Assistance

Complete the roadside assistance identification card and place it in your wallet for quick reference.

In Canada, this card is found in the Warranty Guide in the glove compartment of your vehicle.

## Vehicles Sold in Canada: Roadside Assistance Program Coverage

The service is available 24 hours a day, seven days a week.

Canadian roadside coverage and benefits may differ from the U.S. coverage.

If you require more information, please refer to the coverage section of your warranty guide, call us in Canada at 1-800-665-2006, or visit our website at [www.ford.ca](http://www.ford.ca).

## HAZARD FLASHERS

**Note:** *If used when the vehicle is not running, the battery loses charge. As a result, there may be insufficient power to restart your vehicle.*



E161463

The hazard flasher control is on the steering column. Use it when your vehicle is creating a safety hazard for other motorists.

- Press the flasher control and all front and rear direction indicators flash.
- Press the flasher control again to switch them off.

## JUMP STARTING THE VEHICLE

### WARNINGS



Batteries normally produce explosive gases which can cause personal injury. Therefore, do not allow flames, sparks or lighted substances to come near the battery. When working near the battery, always shield your face and protect your eyes. Always provide correct ventilation.



Keep batteries out of reach of children. Batteries contain sulfuric acid. Avoid contact with skin, eyes or clothing. Shield your eyes when working near the battery to protect against possible splashing of acid solution. In case of acid contact with skin or eyes, flush immediately with water for a minimum of 15 minutes and get prompt medical attention. If acid is swallowed, call a physician immediately.

# Roadside Emergencies

## WARNINGS



Use only adequately sized cables with insulated clamps.

## Preparing Your Vehicle

Do not attempt to push-start your automatic transmission vehicle.

**Note:** Attempting to push-start a vehicle with an automatic transmission may cause transmission damage.

**Note:** Use only a 12-volt supply to start your vehicle.

**Note:** Do not disconnect the battery of the disabled vehicle as this could damage the vehicle electrical system.

Park the booster vehicle close to the hood of the disabled vehicle, making sure the two vehicles do not touch.

## Connecting the Jumper Cables

### WARNINGS



Do not attach the cables to fuel lines, engine rocker covers, the intake manifold or electrical components as grounding points. Stay clear of moving parts. To avoid reverse polarity connections, make sure that you correctly identify the positive (+) and negative (-) terminals on both the disabled and booster batteries before connecting the cables.



Do not attach the end of the positive cable to the studs or L-shaped eyelet located above the positive (+) terminal of your vehicle's battery. High current may flow through and cause damage to the fuses.



Do not connect the end of the second cable to the negative (-) terminal of the battery to be jumped. A spark may cause an explosion of the gases that surround the battery.

**Note:** In the illustration, the bottom vehicle represents the booster vehicle.

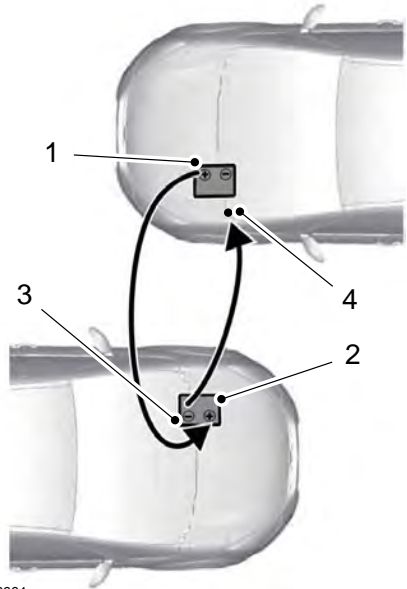

E142664

1. Connect the positive (+) jumper cable to the positive (+) terminal of the discharged battery.
2. Connect the other end of the positive (+) cable to the positive (+) terminal of the booster vehicle battery.
3. Connect the negative (-) cable to the negative (-) terminal of the booster vehicle battery.
4. Make the final connection of the negative (-) cable to an exposed metal part of the stalled vehicle's engine, away from the battery and the fuel injection system, or connect the negative (-) cable to a ground connection point if available.

# Roadside Emergencies

## Jump Starting

1. Start the engine of the booster vehicle and rev the engine moderately, or press the accelerator gently to keep your engine speed between 2000 and 3000 RPM, as shown in your tachometer.
2. Start the engine of the disabled vehicle.
3. Once the disabled vehicle has been started, run both vehicle engines for an additional three minutes before disconnecting the jumper cables.
2. Remove the jumper cable on the negative (-) terminal of the booster vehicle battery.
3. Remove the jumper cable from the positive (+) terminal of the booster vehicle battery.
4. Remove the jumper cable from the positive (+) terminal of the disabled vehicle battery.
5. Allow the engine to idle for at least one minute.

## Removing the Jumper Cables

Remove the jumper cables in the reverse order that they were connected.

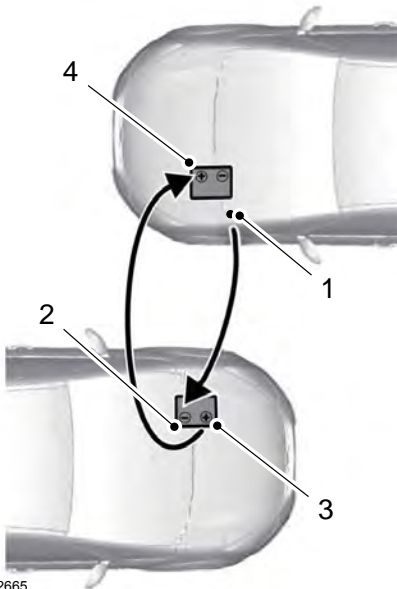

1. Remove the negative (-) jumper cable from the disabled vehicle.

## TRANSPORTING THE VEHICLE

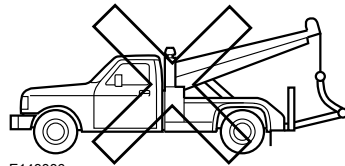
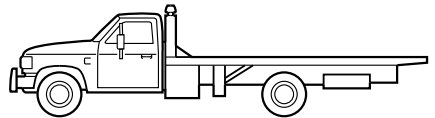
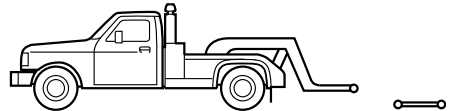

E143886

If you need to have your vehicle towed, contact a professional towing service or, if you are a member of a roadside assistance program, your roadside assistance service provider.

# Roadside Emergencies

---

We recommend the use of a wheel lift and dollies or flatbed equipment to tow your vehicle. Do not tow with a slingbelt. Ford Motor Company has not approved a slingbelt towing procedure. Vehicle damage may occur if towed incorrectly, or by any other means.

Ford Motor Company produces a towing manual for all authorized tow truck operators. Have your tow truck operator refer to this manual for proper hook-up and towing procedures for your vehicle.

It is acceptable to have your front-wheel drive vehicle towed from the front if using proper wheel lift equipment to raise the front wheels off the ground. When towing in this manner, the rear wheels can remain on the ground.

Front-wheel drive vehicles must have the front wheels placed on a tow dolly when towing your vehicle from the rear using wheel lift equipment. This prevents damage to the transmission.

Towing an all-wheel or four-wheel drive vehicle requires that all wheels be off the ground, such as using a wheel lift and dollies or flatbed equipment. This prevents damage to the transmission, all-wheel or four-wheel drive system and vehicle.

# Customer Assistance

## GETTING THE SERVICES YOU NEED

Warranty repairs to your vehicle must be performed by an authorized dealer. While any authorized dealer handling your vehicle line will provide warranty service, we recommend you return to your selling authorized dealer who wants to ensure your continued satisfaction.

Please note that certain warranty repairs require special training and equipment, so not all authorized dealers are authorized to perform all warranty repairs. This means that, depending on the warranty repair needed, you may have to take your vehicle to another authorized dealer.

A reasonable time must be allowed to perform a repair after taking your vehicle to the authorized dealer. Repairs will be made using Ford or Motorcraft® parts, or remanufactured or other parts that are authorized by Ford.

### Away From Home

If you are away from home when your vehicle needs service, contact the Ford Customer Relationship Center or use the online resources listed below to find the nearest authorized dealer.

In the United States:

#### Mailing address

Ford Motor Company  
Customer Relationship Center  
P.O. Box 6248  
Dearborn, MI 48126

#### Telephone

1-800-392-3673 (FORD)  
(TDD for the hearing impaired:  
1-800-232-5952)

Additional information and resources are available online:

Website
<a href="http://www.owner.ford.com">www.owner.ford.com</a>

These are some of the items that can be found online:

- U.S. dealer locator by Dealer Name, City/State or Zip Code.
- Owner Manuals.
- Maintenance Schedules.
- Recalls.
- Ford Extended Service Plans.
- Ford Genuine Accessories.
- Service specials and promotions.

In Canada:

#### Mailing address

Customer Relationship Centre  
Ford Motor Company of Canada, Limited  
P.O. Box 2000  
Oakville, Ontario L6K 0C8

#### Telephone

1-800-565-3673 (FORD)

Website
<a href="http://www.ford.ca">www.ford.ca</a>

#### Twitter

@FordServiceCA (English Canada)  
@FordServiceQC (Quebec)

#### Additional Assistance

If you have questions or concerns, or are unsatisfied with the service you are receiving, follow these steps:

1. Contact your Sales Representative or Service Advisor at your selling or servicing authorized dealer.



# Customer Assistance

---

2. If your inquiry or concern remains unresolved, contact the Sales Manager, Service Manager or Customer Relations Manager.
3. If you require assistance or clarification on Ford Motor Company policies, please contact the Ford Customer Relationship Center.

In order to help us serve you better, please have the following information available when contacting a Customer Relationship Center:

- Vehicle Identification Number.
- Your telephone number (home and business).
- The name of the authorized dealer and city where located.
- The vehicle's current odometer reading.

In some states within the United States, you must directly notify Ford in writing before pursuing remedies under your state's warranty laws, and Ford is also allowed a final repair attempt.

Additionally, in some states within the United States, a consumer has the option of submitting a warranty dispute to the BBB Auto Line before taking action under the Magnuson-Moss Warranty Act, or to the extent allowed by state law, before pursuing replacement or repurchase remedies provided by certain state laws. This dispute handling procedure is not required prior to enforcing state created rights or other rights which are independent of the Magnuson-Moss Warranty Act or state replacement or repurchase laws.

## IN CALIFORNIA (U.S. ONLY)

California Civil Code Section 1793.2(d) requires that, if a manufacturer or its representative is unable to repair a motor vehicle to conform to the vehicle's applicable express warranty after a reasonable number of attempts, the manufacturer shall be required to either replace the vehicle with one substantially identical or repurchase the vehicle and reimburse the buyer in an amount equal to the actual price paid or payable by the consumer (less a reasonable allowance for consumer use). The consumer has the right to choose whether to receive a refund or replacement vehicle.

California Civil Code Section 1793.22(b) presumes that the manufacturer has had a reasonable number of attempts to conform the vehicle to its applicable express warranties if, within the first 18 months of ownership of a new vehicle or the first 18,000 mi (29,000 km), whichever occurs first:

1. Two or more repair attempts are made on the same non-conformity likely to cause death or serious bodily injury OR
2. Four or more repair attempts are made on the same nonconformity (a defect or condition that substantially impairs the use, value or safety of the vehicle) OR
3. The vehicle is out of service for repair of nonconformities for a total of more than 30 calendar days (not necessarily all at one time).

In the case of 1 or 2 above, the consumer must also notify the manufacturer of the need for the repair of the nonconformity at the following address:

Ford Motor Company  
16800 Executive Plaza Drive  
Mail Drop 3NE-B  
Dearborn, MI 48126

# Customer Assistance

---

You are required to submit your warranty dispute to BBB AUTO LINE before asserting in court any rights or remedies conferred by California Civil Code Section 1793.22(b). You are also required to use BBB AUTO LINE before exercising rights or seeking remedies created by the Federal Magnuson-Moss Warranty Act, 15 U.S.C. sec. 2301 et seq. If you choose to seek redress by pursuing rights and remedies not created by California Civil Code Section 1793.22(b) or the Magnuson-Moss Warranty Act, resort to BBB AUTO LINE is not required by those statutes.

## **THE BETTER BUSINESS BUREAU (BBB) AUTO LINE PROGRAM (U.S. ONLY)**

Your satisfaction is important to Ford Motor Company and to your dealer. If a warranty concern has not been resolved using the three-step procedure outlined earlier in this chapter in the Getting the Services you need section, you may be eligible to participate in the BBB AUTO LINE program.

The BBB AUTO LINE program consists of two parts – mediation and arbitration. During mediation, a representative of the BBB will contact both you and Ford Motor Company to explore options for settlement of the claim. If an agreement is not reached during mediation or you do not want to participate in mediation, and if your claim is eligible, you may participate in the arbitration process. An arbitration hearing will be scheduled so that you can present your case in an informal setting before an impartial person. The arbitrator will consider the testimony provided and make a decision after the hearing.

Disputes submitted to the BBB AUTO LINE program are usually decided within forty days after you file your claim with the BBB. You are not bound by the decision, and may reject the decision and proceed to court where all findings of the BBB Auto Line dispute, and decision, are admissible in the court action. Should you choose to accept the BBB AUTO LINE decision, Ford is then bound by the decision, and must comply with the decision within 30 days of receipt of your acceptance letter.

**BBB AUTO LINE Application:** Using the information provided below, please call or write to request a program application. You will be asked for your name and address, general information about your new vehicle, information about your warranty concerns, and any steps you have already taken to try to resolve them. A Customer Claim Form will be mailed that will need to be completed, signed and returned to the BBB along with proof of ownership. Upon receipt, the BBB will review the claim for eligibility under the Program Summary Guidelines.

**You can get more information by calling BBB AUTO LINE at 1-800-955-5100, or writing to:**

**BBB AUTO LINE  
3033 Wilson Boulevard, Suite 600  
Arlington, Virginia 22201**

BBB AUTO LINE applications can also be requested by calling the Ford Motor Company Customer Relationship Center at 1-800-392-3673.

**Note:** *Ford Motor Company reserves the right to change eligibility limitations, modify procedures, or to discontinue this process at any time without notice and without obligation.*

# Customer Assistance

---

## UTILIZING THE MEDIATION/ARBITRATION PROGRAM (CANADA ONLY)

For vehicles delivered to authorized Canadian dealers. In those cases where you continue to feel that the efforts by Ford of Canada and the authorized dealer to resolve a factory-related vehicle service concern have been unsatisfactory, Ford of Canada participates in an impartial third party mediation/arbitration program administered by the Canadian Motor Vehicle Arbitration Plan (CAMVAP).

The CAMVAP program is a straight forward and relatively speedy alternative to resolve a disagreement when all other efforts to produce a settlement have failed. This procedure is without cost to you and is designed to eliminate the need for lengthy and expensive legal proceedings.

In the CAMVAP program, impartial third-party arbitrators conduct hearings at mutually convenient times and places in an informal environment. These impartial arbitrators review the positions of the parties, make decisions and, when appropriate, render awards to resolve disputes. CAMVAP decisions are fast, fair, and final as the arbitrator's award is binding on both you and Ford of Canada.

CAMVAP services are available in all Canadian territories and provinces. For more information, without charge or obligation, call your CAMVAP Provincial Administrator directly at 1-800-207-0685 or visit [www.camvap.ca](http://www.camvap.ca).

## GETTING ASSISTANCE OUTSIDE THE U.S. AND CANADA

Before exporting your vehicle to a foreign country, contact the appropriate foreign embassy or consulate. These officials can inform you of local vehicle registration regulations and where to find unleaded fuel or petrol/gas engines or the proper sulfur fuel for diesel engines.

If you cannot find the proper fuel recommended for your vehicle, contact our Customer Relationship Center.

The use of improper fuels in your vehicle without proper conversion may damage the effectiveness of your emission control system and may cause engine knocking or serious engine damage. Ford Motor Company or Ford of Canada is not responsible for any damage caused by use of improper fuel. Using improper fuels may also result in difficulty importing your vehicle back into the United States.

If your vehicle must be serviced while you are traveling or living in Asia-Pacific Region, Sub-Saharan Africa, U.S. Virgin Islands and/or Puerto Rico, Central America, the Caribbean, and Israel and the Middle East, contact the nearest authorized dealer. If the authorized dealer cannot help you, contact the corresponding Ford Customer Assistance Center:

**FORD MOTOR COMPANY**  
**Customer Relationship Centers in:**

## Customer Assistance

Customer Relationship Center	Phone	Fax	E-mail
Asia Pacific	N/A	N/A	apemrc@ford.com
Caribbean and Central America	+1 313 594 4857	-	expcac@ford.com
Middle East	Ford 80004443673	971 4 3327 266	menacac@ford.com
	Lincoln 80004441067		
	UAE 80004441066		
	Saudi Arabia 8008443673		
	Mobily and Zain cell phone users in Saudi 800850078		
Puerto Rico and U.S. Virgin Islands	+1-800-841-3673	N/A	prcac@ford.com
Sub-Saharan Africa	+1-313-594-4857	N/A	ssacrc@ford.com
South Korea	+82-02-1600-6003	N/A	infokr1@ford.com or infokr@lincoln.com

If you buy your vehicle in North America and then relocate to any of the above locations, register your vehicle identification number (VIN) and new address with Ford Global Trade Services by emailing, [expcso@ford.com](mailto:expcso@ford.com).

If you are in another foreign country, contact the nearest authorized dealer. In the event your inquiry is unresolved, communicate your concern with the dealership's Sales Manager, Service Manager or Customer Relations Manager. If you require additional assistance or clarification, please contact the respective Customer Relationship Center as previously listed.

**Customers in the U.S. should call 1-800-392-3673.**

### ORDERING ADDITIONAL OWNER'S LITERATURE

To order the publications in this portfolio, contact Helm, Incorporated at:

HELM, INCORPORATED  
47911 Halyard Drive  
Plymouth, Michigan 48170  
Attention: Customer Service

Or to order a free publication catalog, call toll free: 1-800-782-4356

Monday-Friday 8:00 a.m. - 6:00 p.m. EST

## Customer Assistance

---

Helm, Incorporated can also be reached by their website:

[www.helminc.com](http://www.helminc.com)

(Items in this catalog may be purchased by credit card, check or money order.)

### **Obtaining a French Owner's Manual**

French Owner's Manual can be obtained from your authorized dealer or by contacting Helm, Incorporated using the contact information listed previously in this section.

### **REPORTING SAFETY DEFECTS (U.S. ONLY)**



E142557

If you believe that your vehicle has a defect which could cause a crash or could cause injury or death, you should immediately inform the National Highway Traffic Safety Administration (NHTSA) in addition to notifying Ford Motor Company.

If NHTSA receives similar complaints, it may open an investigation, and if it finds that a safety defect exists in a group of vehicles, it may order a recall and remedy campaign. However, NHTSA cannot become involved in individual problems between you, your dealer, or Ford Motor Company.

To contact NHTSA, you may call the Vehicle Safety Hotline toll-free at 1-888-327-4236 (TTY: 1-800-424-9153); go to <http://www.safercar.gov>; or write to:

Administrator

1200 New Jersey Avenue,  
Southeast

Washington, D.C. 20590

You can also obtain other information about motor vehicle safety from <http://www.safercar.gov>.

### **REPORTING SAFETY DEFECTS (CANADA ONLY)**

If you believe that your vehicle has a defect which could cause a crash or could cause injury or death, you should immediately inform Transport Canada and Ford of Canada.

# Customer Assistance

---

## Transport Canada Contact Information

Website	<a href="http://www.tc.gc.ca/eng/motorvehiclesafety/reporting-defects-motor-vehicles.html">http://www.tc.gc.ca/eng/motorvehiclesafety/reporting-defects-motor-vehicles.html</a> (English)
Website	<a href="http://www.tc.gc.ca/fra/securiteautomobile/signaler-defauts-vehicules-automobiles.html">http://www.tc.gc.ca/fra/securiteautomobile/signaler-defauts-vehicules-automobiles.html</a> (French)
Phone	1-800-333-0510

## Ford of Canada Contact Information

Website	<a href="http://www.ford.ca">www.ford.ca</a>
Phone	1-800-565-3673

# Fuses

## FUSE SPECIFICATION CHART

### F53 Power Distribution Box

#### WARNINGS



Always disconnect the battery before servicing high current fuses.



To reduce risk of electrical shock, always replace the cover to the power distribution box before reconnecting the battery or refilling fluid reservoirs.

Locate the power distribution box in the engine compartment. It has high-current fuses that protect your vehicle's main electrical systems from overloads.

If the battery has been disconnected and reconnected, you will need to reset some features. See **Changing the 12V Battery** (page 101).

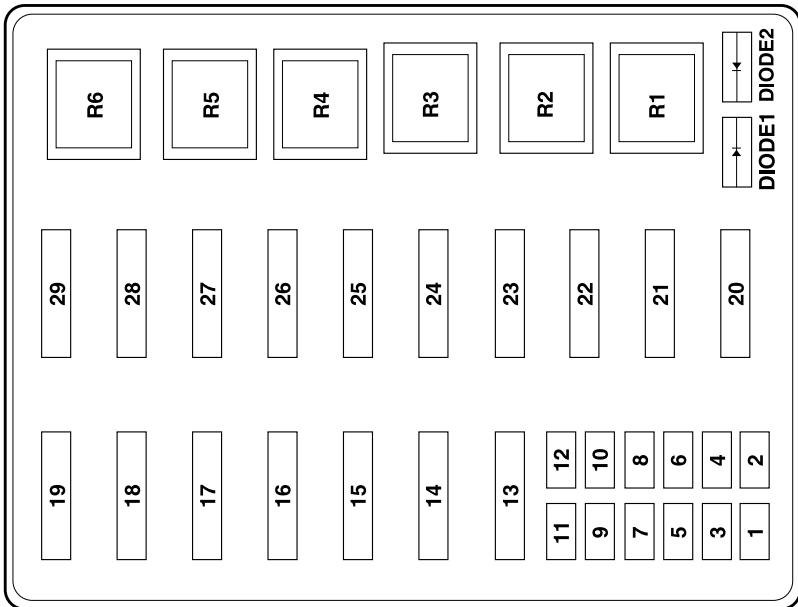

E161519

# Fuses

Fuse or Relay Number	Fuse Rating	Protected Components
1	5A <sup>1</sup>	Power brake assist module – HydroMax.
2	10A <sup>1</sup>	Air conditioning compressor clutch.
3	20A <sup>1</sup>	Catalyst monitor sensor. Engine heated exhaust gas oxygen sensor #11 and #21. Vapor management valve.
4	5A <sup>1</sup>	Powertrain control module relay coil. Powertrain control module keep alive memory.
5	20A <sup>1</sup>	Powertrain control module power.
6	20A <sup>1</sup>	Instrument panel dimmer module. Park lamp feeds. Trailer tow running lamp relay coil.
7	20A <sup>1</sup>	Ignition coils. Radio capacitors.
8	30A <sup>1</sup>	HydroMax – Anti-lock brake system module.
9	10A <sup>1</sup>	Powertrain control module.
10	20A <sup>1</sup>	Daytime running lamps.
11	20A <sup>1</sup>	Fuel pump relay coil. Powertrain control module. Fuel pump diode.
12	25A <sup>1</sup>	Instrument panel - backup lamp feed. Trailer tow backup lamps feed.
13	30A <sup>2</sup>	Trailer tow electric brake controller feed.
14	60A <sup>2</sup>	Instrument panel battery feed (fuse #15, 21). Lighting primary fuse. Power distribution box fuse #19.
15	20A <sup>2</sup>	Trailer tow park lamps.



## Fuses

Fuse or Relay Number	Fuse Rating	Protected Components
16	60A <sup>2</sup>	Anti-lock brake system module – HydroMax.
	40A <sup>2</sup>	Anti-lock brake system module – Hydro-boost.
17	20A <sup>2</sup>	Horn feed.
18	20A <sup>2</sup>	Backup lamp relay coil. A/C clutch coil. A/C demand switch.
19	20A <sup>2</sup>	Brake on/off switch. Multifunction switch.
20	30A <sup>2</sup>	Powertrain control module relay (Power distribution box fuses # 3, 5, 7, 18).
21	20A <sup>2</sup>	Fuel injectors. Fuel pump motor. Mass air flow sensor. Powertrain control module.
22	20A <sup>2</sup>	Cigar lighter feed. Diagnostic tool connector.
23	40A <sup>2</sup>	Blower motor feed.
24	50A <sup>2</sup>	Instrument panel battery feed (fuses #4, 10, 16, 22).
25	40A <sup>2</sup>	Ignition switch feed (Instrument panel fuses #1, 5, 7, 11, 13, 14, 17, 19, 23, 36; Power distribution box fuses #9, 11). Fuse holder #2.
26	40A <sup>2</sup>	Ignition switch feed (Instrument panel fuses #5, 11, 17, 23, 38).
27	30A <sup>2</sup>	Headlamps. Daytime running lamps on/off relay coil. Headlamp daytime running lamp relay feed. High beam headlamps flash to pass. (Instrument panel fuses #25, 31).
28	30A <sup>2</sup>	Starter relay feed.

# Fuses

Fuse or Relay Number	Fuse Rating	Protected Components
		Starter motor solenoid.
29	60A <sup>2</sup>	Power brake assist motor – HydroMax. Fuse holder #1.
	40A <sup>2</sup>	Anti-lock brake system module – Hydro-boost.
R1	—	A/C clutch relay.
R2	—	Fuel pump relay.
R3	—	Horn relay.
R4	—	Starter relay.
R5	—	Blower motor relay.
R6	—	Powertrain control module relay.
Diode 1	—	Fuel pump diode.
Diode 2	—	Air conditioning clutch diode.

<sup>1</sup> Mini fuse.

<sup>2</sup> Maxi fuse.

# Fuses

## F59 Power Distribution Box

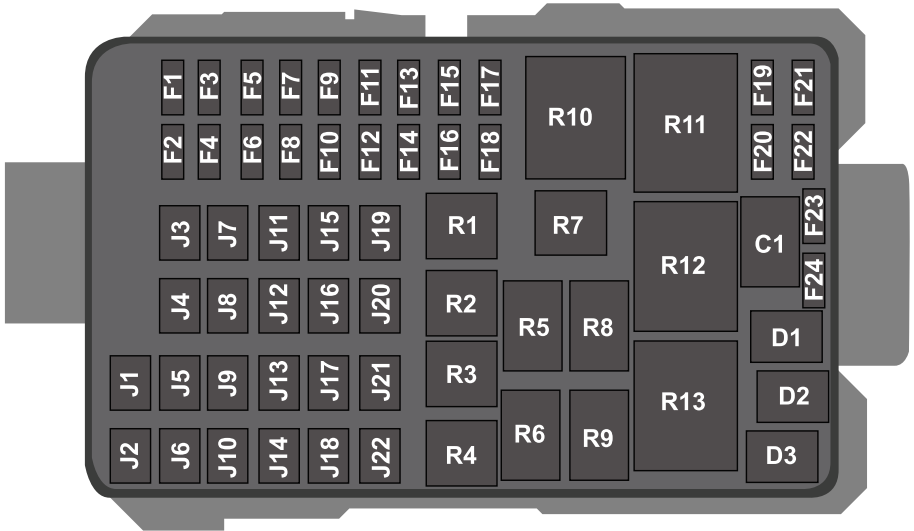

E197657

Fuse or Relay Number	Fuse Rating	Protected Components
F1	10A <sup>1</sup>	Air conditioning compressor clutch.
F2	30A <sup>1</sup>	Anti-lock brake system - HydroMax.
F3	5A <sup>1</sup>	Powertrain control module keep alive memory. Powertrain control module relay coil.
F4	—	Not used.
F5	20A <sup>1</sup>	Trailer tow running lamp relay coil. Park lamp feeds. Instrument panel dimmer module.
F6	—	Not used.

# Fuses

Fuse or Relay Number	Fuse Rating	Protected Components
F7	25A <sup>1</sup>	Trailer tow backup lamp feed. Backup lamp feed.
F8	—	Not used.
F9	20A <sup>1</sup>	Daytime running lamps.
F10	—	Not used.
F11	—	Not used.
F12	—	Not used.
F13	—	Not used.
F14	—	Not used.
F15	5A <sup>1</sup>	Power brake assist module (HydroMax).
F16	20A <sup>1</sup>	Powertrain control module power.
F17	20A <sup>1</sup>	Catalyst monitor sensor. Engine heated exhaust gas oxygen sensor #11 and #21. Vapor management valve.
F18	20A <sup>1</sup>	Radio capacitors. Ignition coils.
F19	10A <sup>1</sup>	Powertrain control module.
F20	10A <sup>1</sup>	HydroMax module brake on/off relay feed.
F21	20A <sup>1</sup>	Powertrain control module. Fuel pump diode. Fuel pump relay coil.
F22	10A <sup>1</sup>	Brake transmission shift interlock.
F23	—	Not used.
F24	—	Not used.
J1	40A <sup>2</sup>	Blower motor relay feed.
J2	30A <sup>2</sup>	Headlamps. High beam headlamps flash to pass.

# Fuses

Fuse or Relay Number	Fuse Rating	Protected Components
		Daytime running lamps on/off relay coil. Headlamp daytime running lamp relay feed. Instrument panel fuses #25, 31.
J3	30A <sup>2</sup>	Vehicle power. Powertrain control module relay feed. Power distribution box fuse F16, F17, F18, J22.
J4	20A <sup>2</sup>	Cigar lighter feed. Diagnostic tool connector.
J5	—	Not used.
J6	30A <sup>2</sup>	Starter relay feed. Starter motor solenoid.
J7	40A <sup>2</sup>	Anti-lock brake system module (Hydroboost).
	60A <sup>2</sup>	Power brake assist motor (HydroMax). Power distribution box fuse #F20.
J8	20A <sup>2</sup>	Trailer tow park lamps.
J9	50A <sup>2</sup>	Instrument panel fuse #4, 10, 16, 22.
J10	60A <sup>2</sup>	HydroMax anti-lock brake system module.
	40A <sup>2</sup>	Hydroboost anti-lock brake system module.
J11	20A <sup>2</sup>	Fuel pump relay feed. Fuel injectors. Mass air flow sensor. Fuel pump motor. Powertrain control module.
J12	30A <sup>2</sup>	Trailer tow electronic brake.
J13	40A <sup>2</sup>	Ignition switch feed (instrument panel fuses #1, 5, 7, 11, 13, 14, 17, 19, 23, 36). (Power distribution box fuse #F19, F22, F21).
J14	—	Not used.

## Fuses

Fuse or Relay Number	Fuse Rating	Protected Components
J15	60A <sup>2</sup>	Instrument panel battery feed (fuse #15, 21). Lighting primary fuse.
J16	20A <sup>2</sup>	Horn.
J17	40A <sup>2</sup>	Ignition switch feed (instrument panel fuses #5, 11, 17, 23, 38).
J18	20A <sup>2</sup>	Brake on/off switch. Multifunction switch.
J19	—	Not used.
J20	—	Not used.
J21	—	Not used.
J22	20A <sup>2</sup>	Reverse lamp relay coil. A/C clutch relay coil. A/C demand switch.
R1	—	Horn relay.
R2	—	Fuel pump relay.
R3	—	Starter relay.
R4	—	Backup lamps relay.
R5	—	Brake on/off signal isolating relay (Hydromax).
R6	—	Trailer tow parking lamps relay.
R7	—	Not used.
R8	—	A/C clutch relay.
R9	—	Not used.
R10	—	Starter relay.
R11	—	Blower motor relay.
R12	—	Daytime running lamp/headlamp relay.
R13	—	Powertrain control module relay.
D1	—	Fuel pump diode.

# Fuses

Fuse or Relay Number	Fuse Rating	Protected Components
D2	—	Air conditioning clutch diode.
D3	—	Not used.
C1	—	Not used.

<sup>1</sup> Mini fuse.

<sup>2</sup> J case fuse.

## UPS Power Distribution Box 1

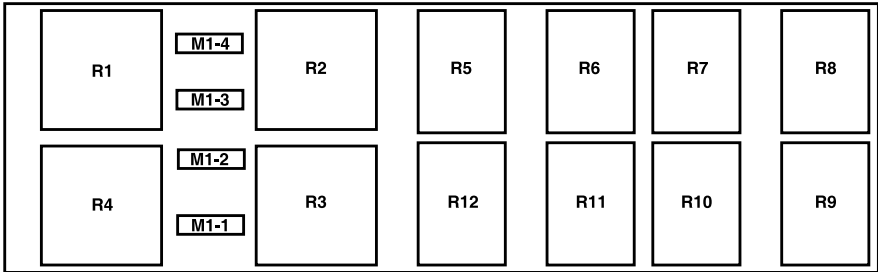

E172543

Fuse or Relay Number	Fuse Rating	Protected Components
R1	Relay	Powertrain control module.
R2	Relay	Daytime running lamps.
R3	Relay	Starter motor.
R4	Relay	Blower motor.
R5	Relay	Horn.
R6	Relay	Fuel pump.
R7	Relay	Starter ground.
R8	Relay	Trailer tow parking lamps.
R9	Relay	Backup lamps.
R10	Relay	Hydromax brake on/off relay.

# Fuses

Fuse or Relay Number	Fuse Rating	Protected Components
R11	Relay	Not used.
R12	Relay	Not used.
M1-1	10A	Hydromax brake on/off relay.
M1-2	10A	Brake shift Interlock (Column shift).
M1-3	5A	Power brake assist module (Hydromax).
M1-4	10A	Powertrain control module.

## UPS Power Distribution Box 2

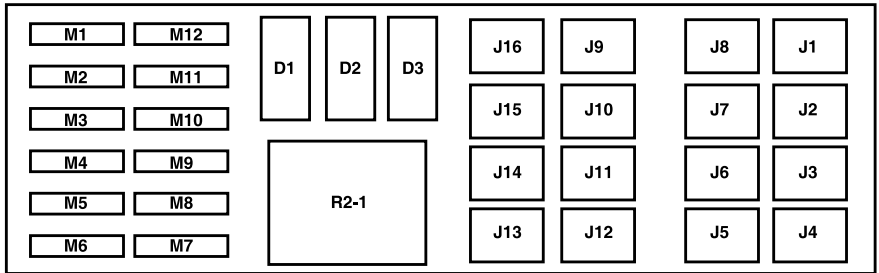

E172544

Fuse or Relay Number	Fuse Rating	Protected Components
M1	25A <sup>1</sup>	Backup lamp feed. Trailer tow backup lamp feed.
M2	20A <sup>1</sup>	Daytime running lamps.
M3	30A <sup>1</sup>	4-channel anti-lock brake system module (Hydromax).
M4	20A <sup>1</sup>	Powertrain control module run/start. Fuel pump relay coil. Fuel pump diode.
M5	10A <sup>1</sup>	Brake lamps.



## Fuses

Fuse or Relay Number	Fuse Rating	Protected Components
M6	20A <sup>1</sup>	Radio capacitors. Ignition coils.
M7	20A <sup>1</sup>	Backup lamp relay coil. Air conditioning clutch coil. Air conditioning demand switch.
M8	20A <sup>1</sup>	Catalyst monitor sensor. Engine heated exhaust gas oxygen sensor #11 and #21. Vapor management valve.
M9	20A <sup>1</sup>	Powertrain control module power.
M10	5A <sup>1</sup>	Brake shift Interlock
M11	5A <sup>1</sup>	Powertrain control module relay keep alive power. Powertrain control module relay coil.
M12	20A <sup>1</sup>	Parking lamps feed.
D1	Diode	Not used.
D2	Diode	Fuel pump.
D3	Diode	Air conditioning clutch.
R2-1	—	Not used.
J1	30A <sup>2</sup>	Powertrain control module relay feed (power distribution box fuse M6, M7, M8, M9).
J2	20A <sup>2</sup>	Fuel injectors. Fuel pump motor. Mass airflow sensor. Powertrain control module.
J3	20A <sup>2</sup>	Cigar lighter power point. Diagnostic connector.
J4	40A <sup>2</sup>	Blower motor.
J5	30A <sup>2</sup>	Headlamps. Daytime running lamps on/off relay coil.

# Fuses

Fuse or Relay Number	Fuse Rating	Protected Components
		Headlamp daytime running lamp relay feed. High beam headlamps flash to pass. (Instrument panel fuses #25, 31).
J6	40A <sup>2</sup>	Ignition switch feeds (instrument panel fuses #F26).
J7	40A <sup>2</sup>	Instrument panel fuses #F24, F22, F20, F26, F21, F8, F6, F4, F2. Power distribution box fuses M4, M1-4.
J8	50A <sup>2</sup>	Instrument panel fuses F11, F13, F15, F17.
J9	30A <sup>2</sup>	Starter relay feed. Starter motor solenoid.
J10	60A <sup>2</sup>	Power distribution box fuse M1-1. Power brake assist motor (HydroMax).
J11	30A <sup>2</sup>	Trailer tow electronic brake.
J12	60A <sup>2</sup>	Lighting primary. Power distribution box fuse M1-2. Instrument panel fuses #F19, F5, F3.
J13	20A <sup>2</sup>	Brake on/off. Hazard.
J14	20A <sup>2</sup>	Horn.
J15	60A <sup>2</sup>	HydroMax anti-lock brake system module.
J16	20A <sup>2</sup>	Trailer tow parking lamps.

<sup>1</sup> Mini fuse.

<sup>2</sup> J case fuse.

## Diode and Relay Module

Locate the module box with the power distribution box in from of the radiator.

# Fuses

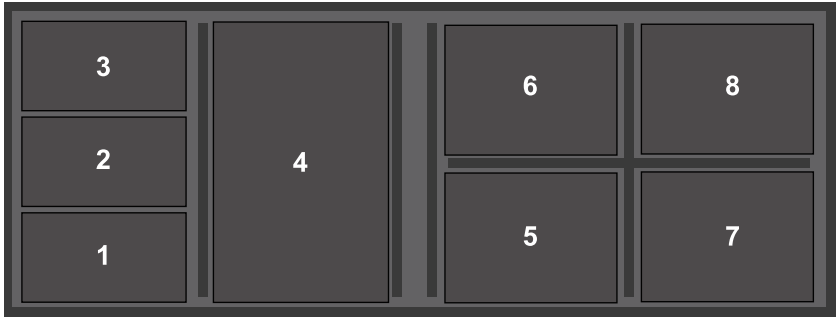

E224614

Relay Number	Protected Components
1	Not used.
2	Not used.
3	Not used.
4	Daytime running lamps power relay.
5	HydroMax – brake on/off signal isolating relay.
6	Reverse lamps relay.
7	Starter ground relay.
8	Trailer tow parking lamps relay.

## Fuse Holder Module

The fuse holder is next to the diode and relay module.

Fuse Number	Fuse Rating	Protected Components
1	10A	Break on/off relay feed (HydroMax module).
2	10A	Brake transmission shift interlock.

# Fuses

## F53 Passenger Compartment Fuse Panel

Locate this fuse panel below and to the left of the steering wheel near the brake

pedal. Remove the panel cover to access the fuses.

To remove a fuse, use the fuse panel cover's fuse puller tool.

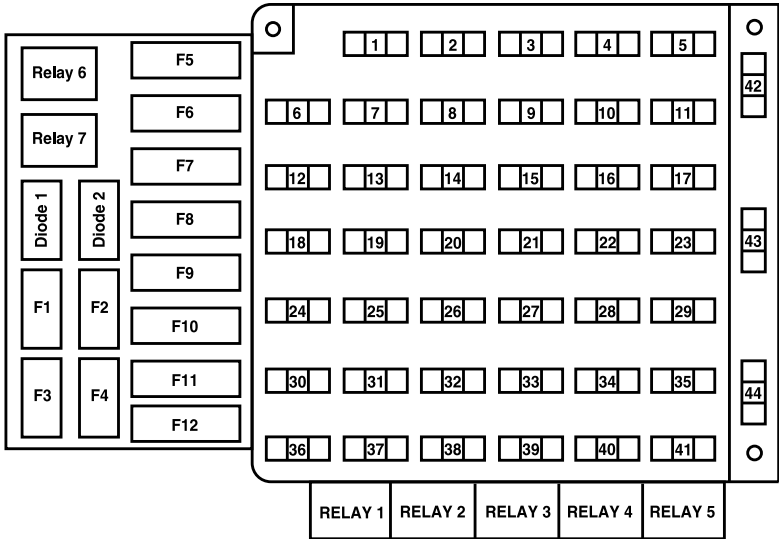

E161521

Fuse or Relay Number	Fuse Rating	Protected Components
1	20A	Multi function switch.
2	—	Not used.
3	—	Not used.
4	10A	Instrument cluster.
5	10A	Body builder accessory feed (accessory and run).
6	—	Not used.

# Fuses

Fuse or Relay Number	Fuse Rating	Protected Components
7	15A	Blower motor relay coil.
8	10A	Brake lamps feed. Trailer brake control module
9	—	Not used.
10	10A	Instrument cluster memory.
11	30A	Wiper/washer module. Wiper feed.
12	—	Not used.
13	10A	Anti-lock brake system module – HydroMax.
14	10A	Anti-lock brake system module – Hydro- boost. Instrument cluster run/start.
15	15A	Left-hand direction indicator feed.
16	20A	Body builder battery (+12V) feed.
17	5A	Body builder radio feed.
18	—	Not used.
19	5A	Daytime running lamps relays.
20	—	Not used.
21	15A	Right-hand direction indicator feed.
22	20A	Trailer tow direction indicators.
23	10A	Cluster run/accessory.
24	—	Not used.
25	10A	Body builder right-hand low beam head- lamp feed.
26	—	Not used.
27	—	Not used.
28	—	Not used.
29	—	Not used.

# Fuses

<b>Fuse or Relay Number</b>	<b>Fuse Rating</b>	<b>Protected Components</b>
30	—	Not used.
31	10A	Body builder left-hand low beam head-lamp feed.
32	—	Not used.
33	10A	Body builder reverse lamp power.
34	10A	Body builder reverse gear. Trailer tow reverse lamps.
35	20A	Body builder high beam feed. High beam indicator.
36	10A	Transmission control switch.
37	—	Not used.
38	10A	Body builder off/run.
39	—	Not used.
40	—	Not used.
41	10A	Instrument cluster lighting/switch illumination.
42	—	Not used.
43	—	Not used.
44	—	Not used.
Relay 1	—	Trailer tow right-hand direction indicator.
Relay 2	—	Trailer tow left-hand direction indicator.
Relay 3	—	Right-hand direction indicator.
Relay 4	—	Left-hand direction indicator.
Relay 5	—	Not used.
Relay 6	—	Daytime running lamps. Parking brake.
Relay 7	—	Daytime running lamps on/off.
Diode 1	—	Not used.

# Fuses

<b>Fuse or Relay Number</b>	<b>Fuse Rating</b>	<b>Protected Components</b>
Diode 2	—	Not used.
F1	—	Not used.
F2	—	Not used.
F3	—	Not used.
F4	—	Not used.
F5	—	Not used.
F6	—	Not used.
F7	—	Not used.
F8	—	Not used.
F9	—	Not used.
F10	—	Not used.
F11	—	Not used.
F12	—	Not used.

# Fuses

## F59 and UPS Passenger Compartment Fuse Panel

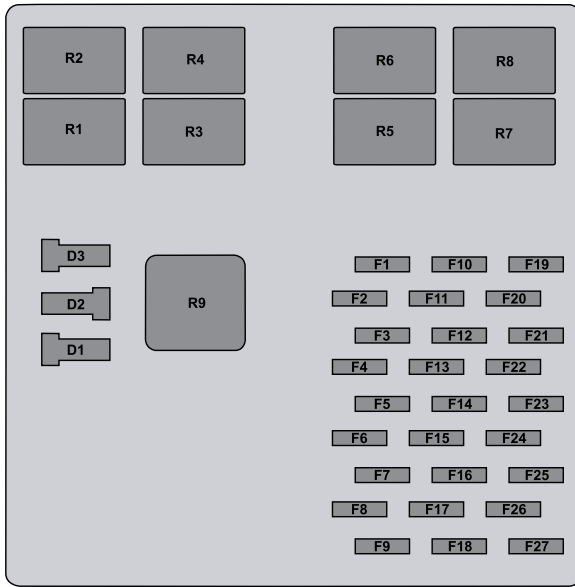

E188334

Fuse or Relay Number	Fuse Rating	Protected Components
F1	—	Not used.
F2	20A	Right/left rear direction indicator. Right/left direction indicator relay coil. Instrument cluster right/direction indicator.
F3	15A	Left turn signal. Hazard lamps.
F4	15A	Blower motor relay coil.
F5	15A	Right front/rear direction indicator. Right front/rear hazard lamp.
F6	10A	Anti-lock brake system module (HydroMax).



# Fuses

Fuse or Relay Number	Fuse Rating	Protected Components
F7	10A	Right low beam headlamp.
F8	5A	Daytime running lamps relays.
F9	10A	Left low beam headlamp.
F10	10A	Transmission control switch.
F11	10A	Cluster battery (+12V) #1.
F12	—	Not used.
F13	10A	Cluster battery (+12V) #2.
F14	10A	Switch illumination. Instrument cluster lighting.
F15	20A	Body builder battery (+12V) feed.
F16	—	Not used.
F17	20A	Trailer tow direction indicators. Trailer tow stop lamps. Trailer tow hazard lamps.
F18	10A	Body builder off/run.
F19	10A	Trailer brake control module Brake on/off signal. Body builder brake lamps. Left/right brake lamps.
F20	10A	Body builder run/accessory feed.
F21	10A	Anti-lock brake system module. Instrument cluster.
F22	30A	Wiper/washer module. Wiper feed.
F23	10A	Reverse lamps.
F24	5A	Body builder radio feed.
F25	10A	Trailer tow reverse lamps.
F26	10A	Cluster run/accessory.
F27	20A	High beam indicator.
R1	Micro relay	Daytime running lamps.

# Fuses

Fuse or Relay Number	Fuse Rating	Protected Components
		Parking brake.
R2	Micro relay	Daytime running lamps on/off.
R3	Micro relay	Right-hand direction indicator.
R4	Micro relay	Trailer tow right-hand direction indicator.
R5	Micro relay	Left-hand direction indicator.
R6	Micro relay	Trailer tow left-hand direction indicator.
R7	—	Not used.
R8	—	Not used.
R9	—	Not used.
D1	—	Not used.
D2	—	Not used.
D3	—	Not used.

## CHANGING A FUSE

### Fuses

#### WARNING



Always replace a fuse with one that has the specified amperage rating. Using a fuse with a higher amperage rating can cause severe wire damage and could start a fire.



E217331

If electrical components in the vehicle are not working, a fuse may have blown. Blown fuses are identified by a broken wire within the fuse. Check the appropriate fuses before replacing any electrical components.

# Fuses

## Fuse Types

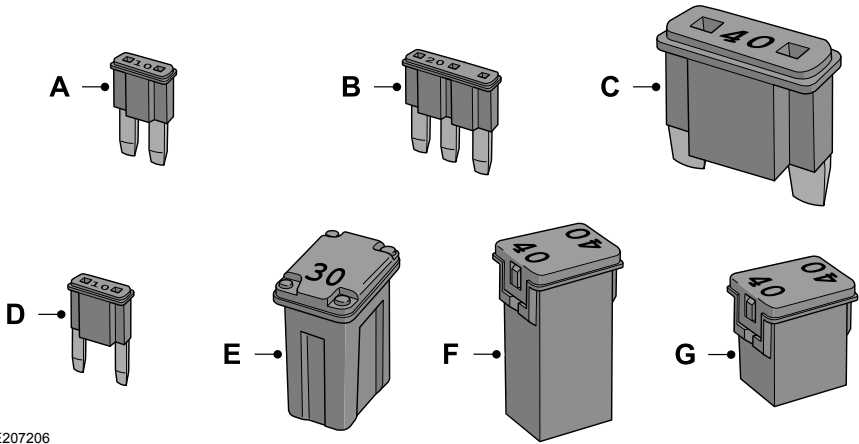

E207206

Callout	Fuse Type
A	Micro 2
B	Micro 3
C	Maxi
D	Mini
E	M Case
F	J Case
G	J Case Low Profile

# Maintenance

---

## GENERAL INFORMATION

Have your vehicle serviced regularly to help maintain its roadworthiness and resale value. There is a large network of authorized dealers that are there to help you with their professional servicing expertise. We believe that their specially trained technicians are best qualified to service your vehicle properly and expertly. They are supported by a wide range of highly specialized tools developed specifically for servicing your vehicle.

If your vehicle requires professional service, an authorized dealer can provide the necessary parts and service. Check your warranty information to find out which parts and services are covered.

Use only recommended fuels, lubricants, fluids and service parts conforming to specifications. Motorcraft® parts are designed and built to provide the best performance in your vehicle.

### Precautions

- Do not work on a hot engine.
- Make sure that nothing gets caught in moving parts.

- Do not work on a vehicle with the engine running in an enclosed space, unless you are sure you have enough ventilation.
- Keep all open flames and other burning material (such as cigarettes) away from the battery and all fuel related parts.

### Working with the Engine Off

1. Set the parking brake and shift to park (P).
2. Switch off the engine.
3. Block the wheels.

### Working with the Engine On

#### WARNING



To reduce the risk of vehicle damage and/or personal burn injuries, do not start your engine with the air cleaner removed and do not remove it while the engine is running.

1. Set the parking brake and shift to park (P).
2. Block the wheels.

## UNDER HOOD OVERVIEW - COMMERCIAL CHASSIS

# Maintenance

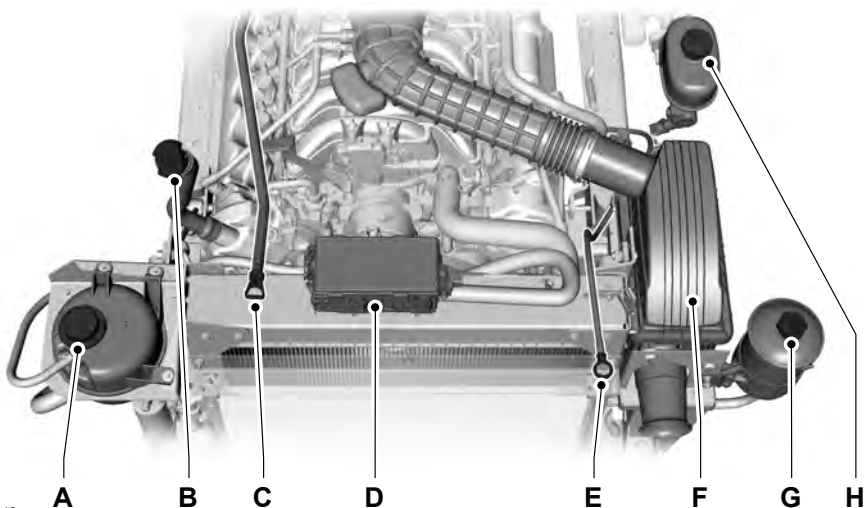

E225840

- A Engine coolant reservoir. See **Engine Coolant Check** (page 93).
- B Engine oil filler cap. See **Engine Oil Check** (page 91).
- C Automatic transmission fluid dipstick. See **Automatic Transmission Fluid Check** (page 97).
- D Engine compartment fuse box. See **Fuses** (page 68).
- E Engine oil dipstick. See **Engine Oil Dipstick** (page 91).
- F Air filter assembly. See **Changing the Engine Air Filter** (page 103).
- G Power steering fluid reservoir. See **Power Steering Fluid Check** (page 100).
- H Brake fluid reservoir. See **Brake Fluid Check** (page 99).

## UNDER HOOD OVERVIEW - MOTORHOME CHASSIS

# Maintenance

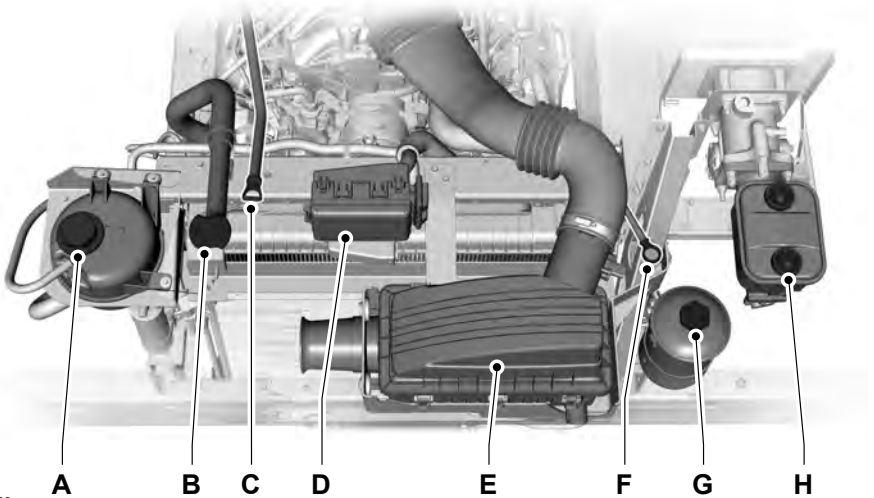

E225839

- A Engine coolant reservoir. See **Engine Coolant Check** (page 93).
- B Engine oil filler cap. See **Engine Oil Check** (page 91).
- C Automatic transmission fluid dipstick. See **Automatic Transmission Fluid Check** (page 97).
- D Engine compartment fuse box. See **Fuses** (page 68).
- E Air filter assembly. See **Changing the Engine Air Filter** (page 103).
- F Engine oil dipstick. See **Engine Oil Dipstick** (page 91).
- G Power steering fluid reservoir. See **Power Steering Fluid Check** (page 100).
- H Brake fluid reservoir. See **Brake Fluid Check** (page 99).

## ENGINE OIL DIPSTICK



E161560

- A MIN
- B MAX

## ENGINE OIL CHECK

To check the engine oil level consistently and accurately, do the following:

# Maintenance

1. Make sure the parking brake is on. Make sure the transmission is in park (P) or neutral (N).
2. Run the engine until it reaches normal operating temperature.
3. Make sure that your vehicle is on level ground.
4. Switch the engine off and wait 15 minutes for the oil to drain into the oil pan. Checking the engine oil level too soon after you switch the engine off may result in an inaccurate reading.
5. Open the hood.
6. Remove the dipstick and wipe it with a clean, lint-free cloth. See **Under Hood Overview** (page 89).
7. Replace the dipstick and remove it again to check the oil level. See **Under Hood Overview** (page 89).
8. Make sure that the oil level is between the maximum and minimum marks. If the oil level is at the minimum mark, add oil immediately. See **Capacities and Specifications** (page 133).
9. If the oil level is correct, replace the dipstick and make sure it is fully seated.

**Note:** Do not remove the dipstick when the engine is running.

**Note:** If the oil level is between the maximum and minimum marks, the oil level is acceptable. Do not add oil.

**Note:** The oil consumption of new engines reaches its normal level after approximately 3,000 mi (5,000 km).

## Adding Engine Oil

### WARNING



Do not remove the filler cap when the engine is running.

Do not use supplemental engine oil additives because they are unnecessary and could lead to engine damage that may not be covered by the vehicle Warranty.



E142732

Only use oils certified for gasoline engines by the American Petroleum Institute (API). An oil with this trademark symbol conforms to the current engine and emission system protection standards and fuel economy requirements of the International Lubricants Specification Advisory Committee (ILSAC).

To top up the engine oil level do the following:

1. Clean the area surrounding the engine oil filler cap before you remove it.
2. Remove the engine oil filler cap. See **Under Hood Overview** (page 89). Turn it counterclockwise and remove it.
3. Add engine oil that meets Ford specifications. See **Capacities and Specifications** (page 133). You may have to use a funnel to pour the engine oil into the opening.
4. Recheck the oil level.
5. If the oil level is correct, replace the dipstick and make sure it is fully seated.
6. Replace the engine oil filler cap. Turn it clockwise until you feel a strong resistance.

# Maintenance

**Note:** Do not add oil further than the maximum mark. Oil levels above the maximum mark may cause engine damage.

**Note:** Make sure you install the oil filler cap correctly.

**Note:** Soak up any spillage with an absorbent cloth immediately.

## OIL CHANGE INDICATOR RESET

### Resetting the Oil Life Monitoring System

Only reset the oil life monitoring system after changing the engine oil and oil filter.

To reset the oil life monitoring system do the following:

1. Switch the ignition on. Do not start the engine.
2. Fully press the accelerator and brake pedals at the same time.
3. Keep the accelerator and brake pedals fully pressed.
4. After three seconds, a message displays confirming the reset procedure is in progress.
5. After 25 seconds, a message displays confirming the reset procedure is complete.
6. Release the accelerator and brake pedals.
7. Switch the ignition off.

## ENGINE COOLANT CHECK

### WARNINGS



Do not remove the coolant reservoir cap when the cooling system is hot. Wait 10 minutes for the cooling system to cool down. Cover the coolant reservoir cap with a thick cloth to prevent the possibility of scalding and slowly remove the cap. Failure to follow this instruction could result in personal injury.



Do not put coolant in the windshield washer fluid reservoir. If sprayed on the windshield, coolant could make it difficult to see through the windshield.



To reduce the risk of personal injury, make sure the engine is cool before unscrewing the coolant pressure relief cap. The cooling system is under pressure. Steam and hot liquid can come out forcefully when you loosen the cap slightly.



Do not add coolant further than the **MAX** mark.

When the engine is cold, check the concentration and level of the coolant at the intervals listed in the scheduled maintenance information. See **Scheduled Maintenance** (page 140).

**Note:** Make sure that the coolant level is between the **MIN** and **MAX** marks on the coolant reservoir.

**Note:** Coolant expands when it is hot. The level may extend beyond the **MAX** mark.

Maintain coolant concentration within 48% to 50%, which equates to a freeze point between -30°F (-34°C) and -34°F (-37°C). Coolant concentration should be checked using a refractometer. We do not recommend the use of hydrometers or coolant test strips for measuring coolant concentration.



# Maintenance

## Adding Coolant

### WARNING



Never remove the coolant reservoir cap when the engine is running or hot.

**Note:** *Automotive fluids are not interchangeable. Take care not to put engine coolant in the windshield washer fluid reservoir or windshield washer fluid in the engine coolant reservoir.*

**Note:** *Do not use stop leak pellets, cooling system sealants, or non-specified additives as they can cause damage to the engine cooling or heating systems. Resulting component damage may not be covered by the vehicle Warranty.*

It is very important to use prediluted coolant approved to the correct specification in order to avoid plugging the small passageways in the engine cooling system. See **Capacities and Specifications** (page 129). Do not mix different colors or types of coolant in your vehicle. Mixing of engine coolants or using an incorrect coolant may harm the engine or cooling system components and may not be covered by the vehicle Warranty.

**Note:** *If prediluted coolant is not available, use the approved concentrated coolant diluting it to 50/50 with distilled water. See **Capacities and Specifications** (page 129). Using water that has not been deionised may contribute to deposit formation, corrosion and plugging of the small cooling system passageways.*

**Note:** *Coolants marketed for all makes and models may not be approved to Ford specifications and may cause damage to the cooling system. Resulting component damage may not be covered by the vehicle Warranty.*

If the coolant level is at or below the minimum mark, add prediluted coolant immediately.

To top up the coolant level do the following:

1. Unscrew the cap slowly. Any pressure escapes as you unscrew the cap.
2. Add prediluted coolant approved to the correct specification. See **Capacities and Specifications** (page 129).
3. Add enough prediluted coolant to reach the correct level.
4. Replace the coolant reservoir cap, turn it clockwise until you feel a strong resistance.
5. Check the coolant level in the coolant reservoir the next few times you drive your vehicle. If necessary, add enough prediluted engine coolant to bring the coolant level to the correct level.

If you have to add more than 1.1 qt (1 L) of engine coolant per month, have your vehicle checked as soon as possible. Operating an engine with a low level of coolant can result in engine overheating and possible engine damage.

**Note:** *During normal vehicle operation, the coolant may change color from orange to pink or light red. As long as the coolant is clear and uncontaminated, this color change does not indicate the coolant has degraded nor does it require the coolant to be drained, the system to be flushed, or the coolant to be replaced.*

In case of emergency, you can add a large amount of water without engine coolant in order to reach a vehicle service location. In this instance, qualified personnel:

1. Must drain the cooling system.
2. Chemically clean the coolant system with Motorcraft Premium Cooling System Flush.

# Maintenance

3. Refill with engine coolant as soon as possible.

Water alone, without engine coolant, can cause engine damage from corrosion, overheating or freezing.

Do not use the following as a coolant substitute:

- Alcohol.
- Methanol.
- Brine.
- Any coolant mixed with alcohol or methanol antifreeze.

Alcohol and other liquids can cause engine damage from overheating or freezing.

Do not add extra inhibitors or additives to the coolant. These can be harmful and compromise the corrosion protection of the coolant.

## Recycled Coolant

We do not recommend the use of recycled coolant as an approved recycling process is not yet available.

Dispose of used engine coolant in an appropriate manner. Follow your community's regulations and standards for recycling and disposing of automotive fluids.

## Severe Climates

If you drive in extremely cold climates:

- It may be necessary to increase the coolant concentration above 50%.
- A coolant concentration of 60% provides improved freeze point protection. Coolant concentrations above 60% decrease the overheat protection characteristics of the coolant and may cause engine damage.

If you drive in extremely hot climates:

- You can decrease the coolant concentration to 40%.
- Coolant concentrations below 40% decrease the freeze and corrosion protection characteristics of the coolant and may cause engine damage.

Vehicles driven year-round in non-extreme climates should use prediluted coolant for optimum cooling system and engine protection.

## Coolant Change

At specific mileage intervals, as listed in the scheduled maintenance information, the coolant should be changed. Add prediluted coolant approved to the correct specification. See **Capacities and Specifications** (page 129).

## Fail-Safe Cooling

Fail-safe cooling allows you to temporarily drive your vehicle before any incremental component damage occurs. The fail-safe distance depends on ambient temperature, vehicle load and terrain.

## How Fail-Safe Cooling Works



If the engine begins to overheat, the coolant temperature gauge moves toward the red zone:



A warning lamp illuminates and a message may appear in the information display.

If the engine reaches a preset over-temperature condition, the engine automatically switches to alternating cylinder operation. Each disabled cylinder acts as an air pump and cools the engine.

# Maintenance

When this occurs, your vehicle still operates, however:

- Engine power is limited.
- The air conditioning system turns off.

Continued operation increases the engine temperature, causing the engine to completely shut down. Your steering and braking effort increases in this situation.

When the engine temperature cools, you can re-start the engine. Have your vehicle checked as soon as possible to minimize engine damage.

## When Fail-Safe Mode Is Activated

### WARNINGS



Fail-safe mode is for use during emergencies only. Operate your vehicle in fail-safe mode only as long as necessary to bring your vehicle to rest in a safe location and seek immediate repairs. When in fail-safe mode, your vehicle will have limited power, will not be able to maintain high-speed operation, and may completely shut down without warning, potentially losing engine power, power steering assist, and power brake assist, which may increase the possibility of a crash resulting in serious injury.



Never remove the coolant reservoir cap when the engine is running or hot.

Your vehicle has limited engine power when in the fail-safe mode, drive your vehicle with caution. Your vehicle does not maintain high-speed operation and the engine may operate poorly.

Remember that the engine is capable of automatically shutting down to prevent engine damage. In this situation:

1. Pull off the road as soon as safely possible and switch the engine off.

2. If you are a member of a roadside assistance program, we recommend that you contact your roadside assistance service provider.
3. If this is not possible, wait a short period for the engine to cool.
4. Check the coolant level. If the coolant level is at or below the minimum mark, add prediluted coolant immediately.
5. When the engine temperature cools, you can re-start the engine. Have your vehicle checked as soon as possible to minimize engine damage.

**Note:** *Driving your vehicle without repair increases the chance of engine damage.*

## Engine Coolant Temperature Management (If Equipped)

### WARNING



To reduce the risk of crash and injury, be prepared that the vehicle speed may reduce and the vehicle may not be able to accelerate with full power until the coolant temperature reduces.

If you tow a trailer with your vehicle, the engine may temporarily reach a higher temperature during severe operating conditions, for example ascending a long or steep grade in high ambient temperatures.

At this time, you may notice the coolant temperature gauge moves toward the red zone and a message may appear in the information display.

# Maintenance

---

You may notice a reduction in vehicle speed caused by reduced engine power in order to manage the engine coolant temperature. Your vehicle may enter this mode if certain high-temperature and high-load conditions take place. The amount of speed reduction depends on vehicle loading, grade and ambient temperature. If this occurs, there is no need to pull off the road. You can continue to drive your vehicle.

The air conditioning may automatically turn on and off during severe operating conditions to protect the engine from overheating. When the coolant temperature decreases to the normal operating temperature, the air conditioning turns on.

If the coolant temperature gauge moves fully into the red zone, or if the coolant temperature warning or service engine soon messages appear in your information display, do the following:

1. Pull off the road as soon as safely possible and shift the transmission into park **(P)**.
2. Leave the engine running until the coolant temperature gauge needle returns to the normal position. After several minutes, if the temperature does not drop, follow the remaining steps.
3. Switch the engine off and wait for it to cool. Check the coolant level.
4. If the coolant level is at or below the minimum mark, add prediluted coolant immediately.
5. If the coolant level is normal, restart the engine and continue.

## AUTOMATIC TRANSMISSION FLUID CHECK

### WARNING



The dipstick cap and surrounding components may be hot; gloves are recommended.

---

**Note:** *Automatic transmission fluid expands when warmed. To obtain an accurate fluid check, drive the vehicle until it is at normal operating temperature (approximately 20 miles [30 km]). If your vehicle has been operated for an extended period at high speeds, in city traffic during hot weather or pulling a trailer, the vehicle should be turned off for about 30 minutes to allow fluid to cool to normal operating temperature 196°F - 215°F (91°C - 102°C) before checking.*

Refer to your scheduled maintenance information for scheduled intervals for fluid checks and changes.

Your transmission does not consume fluid. However, the fluid level should be checked if the transmission is not working properly, (i.e., if the transmission slips or shifts slowly) or if you notice some sign of fluid leakage. To check the fluid level:

1. Drive the vehicle 20 miles (30 km) or until it reaches normal operating temperature
2. Park the vehicle on a level surface and engage the parking brake
3. With the engine running, parking brake engaged and your foot on the brake pedal, move the gearshift lever through all of the gear ranges. Allow sufficient time for each gear to engage
4. Latch the gearshift lever in P (Park) and leave the engine running.

# Maintenance

5. Remove the dipstick, wiping it clean with a clean, dry lint free rag. If necessary, refer to Under Hood Overview in this chapter for the location of the dipstick.
6. Install the dipstick making sure it is fully seated in the filler tube.
7. Remove the dipstick and inspect the fluid level. The fluid should be in the designated area for normal operating temperature or ambient temperature.

Do not use supplemental transmission fluid additives, treatments or cleaning agents. The use of these materials may affect transmission operation and result in damage to internal transmission components.

## Low fluid level



E161551

Do not drive the vehicle if there is no indication of fluid on the dipstick and the ambient temperature is above 50°F (10°C).

## Correct fluid level



E161552

The transmission fluid should be in this range if at normal operating temperature 196°F - 215°F (91°C - 102°C).

The transmission fluid should be checked at normal operating temperature 196°F - 215°F (91°C - 102°C) on a level surface. The normal operating temperature can be reached after approximately 20 miles (30 km) of driving. You can check the fluid without driving if the ambient temperature is above 50°F (10°C). However, if fluid is added at this time, an overfill condition could result when the vehicle reaches normal operating temperature.

## High fluid level



E161553

Fluid levels above the safe range may result in transmission failure. An overfill condition of transmission fluid may cause shift and/or engagement concerns and/or possible damage. High fluid levels can be caused by an overheating condition.

## Adjusting automatic transmission fluid levels

**Note:** Use of a non-approved automatic transmission fluid may cause internal transmission damage. Before adding any fluid, make sure the correct type is used. The type of fluid used is normally indicated on the transmission dipstick and also in the See **Capacities and Specifications** (page 129).

# Maintenance



E161554

Add fluid in ½ pint (250 ml) increments through the filler tube until the level is correct.

**Note:** *If an overfill occurs, excess fluid should be removed by an authorized dealer. An overfill condition of transmission fluid may cause shift and/or engagement concerns and/or possible damage.*

Do not use supplemental transmission fluid additives, treatments or cleaning agents. The use of these materials may affect transmission operation and result in damage to internal transmission components.

## Automatic transmission fluid filter

The TorqShift6™ automatic transmission is equipped with a serviceable transmission fluid filter located inside the transmission bottom pan. Refer to the scheduled maintenance information for service intervals for the automatic transmission fluid and transmission filter. For transmission filter maintenance, see your authorized dealer.

## BRAKE FLUID CHECK

Fluid levels between the MIN and MAX lines are within the normal operating range; there is no need to add fluid. If the fluid levels are outside of the normal operating range, the performance of the system could be compromised; seek service from your authorized dealer immediately.

## Hydromax

### WARNINGS

 Carefully read cautionary information on product label. For MEDICAL EMERGENCY INFORMATION contact a physician or Poison Control Center immediately; on Ford-Motorcraft™ products call: 1-800-959-3673 (FORD). Failure to follow these instructions may result in personal injury.

 Use of any brake fluid other than that indicated for your brake system will cause permanent damage.

 Do not let the reservoir for the master cylinder run dry. This may cause the brakes to fail and result in personal injury.

Chassis with gross vehicle weight ratings of 20500 pounds (9299 kilograms), 22000 pounds (9979 kilograms), 24000 pounds (10886 kilograms) and 26000 pounds (11793 kilograms) are equipped with Hydromax Brake Booster Systems and must use Motorcraft DOT 5.1 Motor Vehicle Brake Fluid or equivalent meeting Ford Specification ESD-M6C57-A. See **Capacities and Specifications** (page 133).

Add fluid up to the bottom of the rings located at the top of the reservoir. Do not fill above this line.



E161555

# Maintenance

- Use only DOT 5.1 brake fluid that is certified to meet Ford specifications.
- A clear gel-like substance in the hydraulic brake master cylinder reservoir may appear on some vehicles. This substance is a silicone base lubricant used during assembly of the master cylinder. It will float on top of the brake hydraulic fluid in the master cylinder. This condition is normal and in no way affects the operation of the brake system. It does not require any service.
- Brake system fluid should be replaced on a regular basis to maintain optimum braking performance, especially under heavy-duty driving conditions such as frequent steep grades or heavy towing loads. See **Scheduled Maintenance** (page 140).

## Hydroboost

Chassis with gross vehicle weight ratings of 16000 pounds (7257 kilograms), 18000 pounds (8165 kilograms) and 19500 pounds (8845 kilograms) are equipped with Hydroboost Brake Booster Systems and must use Motorcraft High Performance DOT 3 Motor Vehicle Brake Fluid or equivalent meeting Ford Specification WSS-M6C62-A.

Add brake fluid from a clean unopened container until the level reaches MAX. Do not fill above this line. Use only DOT 3 brake fluid that is certified to meet Ford specifications.

Brake system fluid should be replaced on a regular basis to maintain optimum braking performance, especially under heavy-duty driving conditions such as frequent steep grades or heavy towing loads. See **Scheduled Maintenance** (page 140).

## POWER STEERING FLUID CHECK

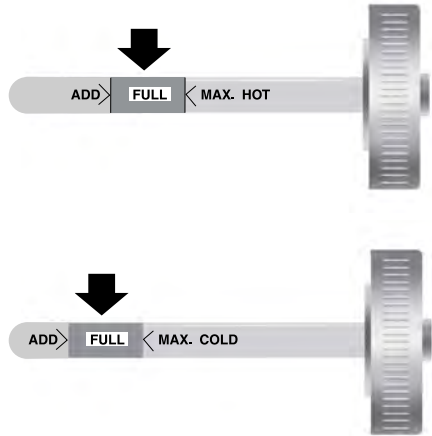

E161557

**Note:** The power steering cap has both a cold and hot indicator on the dipstick.

1. Start the engine and let it run until it reaches normal operating temperature (the engine coolant temperature gauge indicator will be near the center of the normal area between H and C).
2. While the engine idles, turn the steering wheel left and right several times.
3. Turn the engine off.

# Maintenance

4. Check the fluid level on the dipstick. It should be between the arrows in the FULL range on the side of the dipstick with the words MAX. HOT at the top. Do not add fluid if the level is within this range.
5. If the fluid is low, add fluid in small amounts, continuously checking the

level until it reaches the FULL range. Be sure to put the dipstick back in the reservoir.

## Steering linkage lubrication points

There are nine lubrication points on the steering linkage: See **Capacities and Specifications** (page 133).

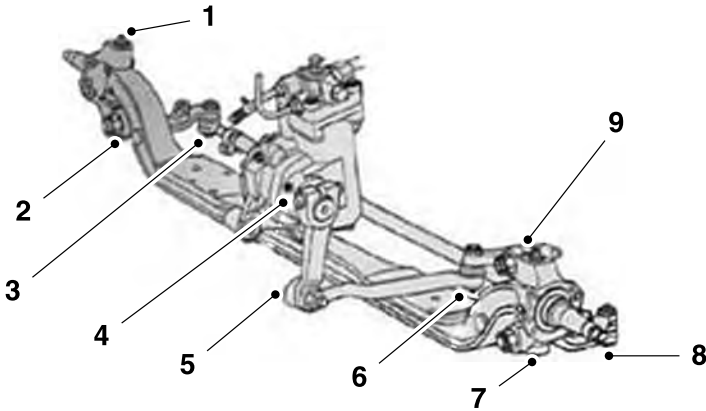

E161558

- **1 and 9** - Top of the king pin.
- **2 and 7** - Bottom of king pin.
- **3 and 8** - Right hand and Left hand tie rod end.
- **4** - Steering gear.
- **5 and 6** - Drag link.

## FUEL FILTER

Your vehicle is equipped with a lifetime fuel filter that is integrated with the fuel tank. Regular maintenance or replacement is not needed.

## CHANGING THE 12V BATTERY

### WARNINGS



Batteries normally produce explosive gases which can cause personal injury. Therefore, do not allow flames, sparks or lighted substances to come near the battery. When working near the battery, always shield your face and protect your eyes. Always provide proper ventilation.



# Maintenance

## WARNINGS



When lifting a plastic-cased battery, excessive pressure on the end walls could cause acid to flow through the vent caps, resulting in personal injury and damage to the vehicle or battery. Lift the battery with a battery carrier or with your hands on opposite corners.



Keep batteries out of reach of children. Batteries contain sulfuric acid. Avoid contact with skin, eyes or clothing. Shield your eyes when working near the battery to protect against possible splashing of acid solution. In case of acid contact with skin or eyes, flush immediately with water for a minimum of 15 minutes and get prompt medical attention. If acid is swallowed, call a physician immediately.

**Note:** *If your battery has a cover/shield, make sure it is reinstalled after the battery has been cleaned or replaced.*

**Note:** *Battery posts, terminals and related accessories contain lead and lead compounds. Wash hands after handling.*

Your vehicle is equipped with a Motorcraft® maintenance-free battery which normally does not require additional water during its life of service.

For longer, trouble-free operation, keep the top of the battery clean and dry. Also, make certain the battery cables are always tightly fastened to the battery terminals.

If you see any corrosion on the battery or terminals, remove the cables from the terminals and clean with a wire brush. You can neutralize the acid with a solution of baking soda and water.

It is recommended that the negative battery cable terminal be disconnected from the battery if you plan to store your vehicle for an extended period of time.

To ensure proper operation of the battery management system (BMS), any electrical devices that are added to the vehicle should not have their ground connection made directly at the negative battery post. A connection at the negative battery post can cause inaccurate measurements of the battery condition and potential incorrect system operation.

**Note:** *Electrical or electronic accessories or components added to the vehicle by the dealer or the owner may adversely affect battery performance and durability and may also affect the performance of other electrical systems in the vehicle.*

When a battery replacement is required, the battery should only be replaced with a Ford recommended replacement battery that matches the electrical requirements of the vehicle.

**Note:** *Always dispose of automotive batteries in a responsible manner. Follow your local authorized standards for disposal. Call your local authorized recycling center to find out more about recycling automotive batteries.*

## Battery relearn

When the battery is disconnected or a new battery installed:

# Maintenance

- The transmission must relearn its adaptive strategy. As a result of this, the transmission may shift firmly. This operation is considered normal and will not affect function or durability of the transmission. Over time the adaptive learning process will fully update transmission operation to its optimum shift feel.
- The clock and the preset radio stations must be reset once the battery is reconnected.
- Your vehicle's engine is electronically controlled by a computer, some control conditions are maintained by power from the battery, the engine must relearn its idle and fuel trim strategy.

When the battery is disconnected or a new battery is installed, begin the battery relearn process:

1. With the vehicle at a complete stop, set the parking brake.
2. Put the gearshift lever in **P** (Park), turn off all accessories and start the engine.
3. Run the engine until it reaches normal operating temperature.
4. Allow the engine to idle for at least one minute.
5. Turn the A/C on and allow the engine to idle for at least one minute.
6. Drive the vehicle to complete the relearning process.
  - The vehicle may need to be driven to relearn the idle and fuel trim strategy.

## CHANGING THE ENGINE AIR FILTER

### WARNING



To reduce the risk of vehicle damage and personal burn injuries, do not start your engine with the air cleaner removed and do not remove it while the engine is running.

Change the air filter element at the proper interval. See **Scheduled Maintenance** (page 140).

When changing the air filter element, use only the air filter element listed. See **Capacities and Specifications** (page 129).

**Note:** *Failure to use the correct air filter element may result in severe engine damage. The customer warranty may be void for any damage to the engine if the correct air filter element is not used.*

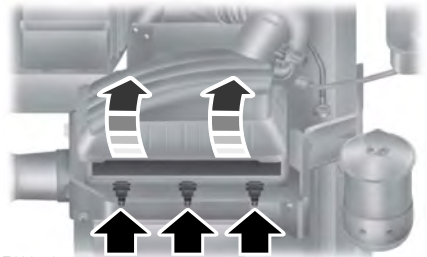

E161559

1. Loosen the latches that secure the air filter cover in place.
2. Carefully separate the two halves of the air filter housing.
3. Remove the air filter element from the housing.
4. Wipe any dirt or debris from the air filter housing and cover.

# Maintenance

---

5. Install a new air filter element.
6. Replace the air filter cover to the housing and secure the latches. Be careful not to crimp the filter element edges between the air filter housing. This could cause filter damage and allow unmetered air to enter the engine if not properly seated.

# Vehicle Care

---

## GENERAL INFORMATION

Your dealer has many quality products available to clean your vehicle and protect its finishes.

## CLEANING THE EXTERIOR

Wash your vehicle regularly with cool or lukewarm water and a neutral pH shampoo, we recommend Motorcraft Detail Wash.

- Never use strong household detergents or soap, for example dish washing or laundry liquid. These products can discolor and spot painted surfaces.
- Never wash your vehicle when it is hot to the touch, or during strong or direct sunlight.
- Dry your vehicle with a chamois or soft terry cloth towel to eliminate water spotting.
- Immediately remove fuel spillages, bird droppings, insect deposits and road tar. These may cause damage to your vehicle's paintwork or trim over time. We recommend Motorcraft Bug and Tar Remover.
- Remove any exterior accessories, for example antennas, before entering a car wash.

**Note:** *Suntan lotions and insect repellents can damage painted surfaces. If these substances come in contact with your vehicle, wash the affected area as soon as possible.*

## Cleaning the Headlamps

**Note:** *Do not scrape the headlamp lenses or use abrasives, alcoholic solvents or chemical solvents to clean them.*

**Note:** *Do not wipe the headlamps when they are dry.*

## Exterior Chrome Parts

- Apply a high quality-cleaning product to bumpers and other chrome parts. Follow the manufacturer's instructions. We recommend Motorcraft Custom Bright Metal Cleaner.
- Do not apply the cleaning product to hot surfaces. Do not leave the cleaning product on chrome surfaces longer than the time recommended.
- Using non-recommended cleaners can result in severe and permanent cosmetic damage.

**Note:** *Never use abrasive materials, for example steel wool or plastic pads as they can scratch the chrome surface.*

**Note:** *Do not use chrome cleaner, metal cleaner or polish on wheels or wheel covers.*

## Exterior Plastic Parts

For routine cleaning we recommend Motorcraft Detail Wash. If tar or grease spots are present, we recommend Motorcraft Bug and Tar Remover.

## Stripes or Graphics (If Equipped)

Hand washing your vehicle is preferred however, pressure washing may be used under the following conditions:

- Do not use water pressure higher than 2,000 psi (14,000 kPa).
- Do not use water hotter than 179°F (82°C).
- Use a spray with a 40° wide spray angle pattern.
- Keep the nozzle at a 12 in (305 mm) distance and 90° angle to your vehicle's surface.

**Note:** *Holding the pressure washer nozzle at an angle to the vehicle's surface may damage graphics and cause the edges to peel away from the vehicle's surface.*

# Vehicle Care

---

## Underbody

Regularly clean the underside of your vehicle using water. Keep body and door drain holes free of debris or foreign material.

## Under Hood

For removing black rubber marks from under the hood we recommend Motorcraft Wheel and Tire Cleaner or Motorcraft Bug and Tar Remover.

## CLEANING THE ENGINE

Engines are more efficient when they are clean because grease and dirt buildup keep the engine warmer than normal.

When washing:

- Take care when using a power washer to clean the engine. The high-pressure fluid could penetrate the sealed parts and cause damage.
- Do not spray a hot engine with cold water to avoid cracking the engine block or other engine components.
- Spray Motorcraft Engine Shampoo and Degreaser on all parts that require cleaning and pressure rinse clean. In Canada, use Motorcraft Engine Shampoo.
- Never wash or rinse the engine while it is hot or running; water in the running engine may cause internal damage.
- Never wash or rinse any ignition coil, spark plug wire or spark plug well, or the area in and around these locations.
- Cover the battery, power distribution box, and air filter assembly to prevent water damage when cleaning the engine.

## CLEANING THE WHEELS (if

Equipped)

1. Regularly clean them with a wheel cleaner. We recommend that you use Ford approved wheel cleaner if available.
2. Remove dirt and brake dust with a sponge.
3. Remove tar and grease with a bug and tar remover. We recommend that you use Ford approved bug and tar remover if available.
4. Thoroughly rinse the wheels with water after cleaning.

If you intend on parking your vehicle for an extended period after cleaning the wheels with a wheel cleaner, drive your vehicle for a few minutes before doing so. This reduces the risk of corrosion of the brake discs, brake pads and linings.

Do not clean the wheels when they are hot.

**Note:** *Some car washes could damage wheel rims and covers.*

**Note:** *Using non-recommended cleaners, harsh cleaning products, chrome wheel cleaners or abrasive materials could damage wheel rims and covers.*

## VEHICLE STORAGE

If you plan on storing your vehicle for 30 days or more, read the following maintenance recommendations to make sure your vehicle stays in good operating condition.

We engineer and test all motor vehicles and their components for reliable, regular driving. Under various conditions, long-term storage may lead to degraded engine performance or failure unless you use specific precautions to preserve engine components.

# Vehicle Care

---

## General

- Store all vehicles in a dry, ventilated place.
- Protect from sunlight, if possible.
- If vehicles are stored outside, they require regular maintenance to protect against rust and damage.

## Body

- Wash your vehicle thoroughly to remove dirt, grease, oil, tar or mud from exterior surfaces, rear-wheel housing and the underside of front fenders.
- Periodically wash your vehicle if it is stored in exposed locations.
- Touch-up exposed or primed metal to prevent rust.
- Cover chrome and stainless steel parts with a thick coat of auto wax to prevent discoloration. Re-wax as necessary when you wash your vehicle.
- Lubricate all hood, door and luggage compartment hinges and latches with a light grade oil.
- Cover interior trim to prevent fading.
- Keep all rubber parts free from oil and solvents.

## Engine

- Change the engine oil and filter prior to storage because used engine oil contains contaminants which may cause engine damage.
- Start the engine every 15 days for a minimum of 15 minutes. Run at fast idle with the climate controls set to defrost until the engine reaches normal operating temperature.

- With your foot on the brake, shift through all the gears while the engine is running.
- We recommend that you change the engine oil before you use your vehicle again.

## Fuel system

- Fill the fuel tank with high-quality fuel until the first automatic shutoff of the fuel pump nozzle.

## Cooling system

- Protect against freezing temperatures.
- When removing your vehicle from storage, check coolant fluid level. Confirm that there are no cooling system leaks and that fluid is at the recommended level.

## Battery

- Check and recharge as necessary. Keep connections clean.
- If storing your vehicle for more than 30 days without recharging the battery, we recommend that you disconnect the battery cables to maintain battery charge for quick starting.

**Note:** *It is necessary to reset memory features if battery cables are disconnected.*

## Brakes

- Make sure the brakes and parking brake release fully.

## Tires

- Maintain recommended air pressure.

# Vehicle Care

---

## Miscellaneous

- Make sure all linkages, cables, levers and pins under your vehicle are covered with grease to prevent rust.
- Move vehicles at least 25 ft (7,5 m) every 15 days to lubricate working parts and prevent corrosion.

## Removing Vehicle From Storage

When your vehicle is ready to come out of storage, do the following:

- Wash your vehicle to remove any dirt or grease film build-up on window surfaces.
- Check windshield wipers for any deterioration.
- Check under the hood for any foreign material that may have collected during storage such as mice or squirrel nests.
- Check the exhaust for any foreign material that may have collected during storage.
- Check tire pressures and set tire inflation per the Tire Label.
- Check brake pedal operation. Drive your vehicle 15 ft (4.5 m) back and forth to remove rust build-up.
- Check fluid levels (including coolant, oil and gas) to make sure there are no leaks, and fluids are at recommended levels.
- If you remove the battery, clean the battery cable ends and check for damage.

Contact an authorized dealer if you have any concerns or issues.

# Wheels and Tires

## TIRE CARE

### Information About Uniform Tire Quality Grading



E142542

Tire Quality Grades apply to new pneumatic passenger car tires. The Quality grades can be found where applicable on the tire sidewall between tread shoulder and maximum section width. For example: **Treadwear 200 Traction AA Temperature A.**

These Tire Quality Grades are determined by standards that the United States Department of Transportation has set.

Tire Quality Grades apply to new pneumatic passenger car tires. They do not apply to deep tread, winter-type snow tires, space-saver or temporary use spare tires, light truck or LT type tires, tires with nominal rim diameters of 10 to 12 inches or limited production tires as defined in Title 49 Code of Federal Regulations Part 575.104 (c)(2).

### U.S. Department of Transportation Tire quality grades:

The U.S. Department of Transportation requires Ford Motor Company to give you the following information about tire grades exactly as the government has written it.

### Treadwear

The treadwear grade is a comparative rating based on the wear rate of the tire when tested under controlled conditions on a specified government test course. For example, a tire graded 150 would wear 1 ½ times as well on the government course as a tire graded 100. The relative performance of tires depends upon the actual conditions of their use, however, and may depart significantly from the norm due to variations in driving habits, service practices, and differences in road characteristics and climate.

### Traction AA A B C

#### WARNING



The traction grade assigned to this tire is based on straight-ahead braking traction tests, and does not include acceleration, cornering, hydroplaning or peak traction characteristics.



# Wheels and Tires

The traction grades, from highest to lowest are AA, A, B, and C. The grades represent the tire's ability to stop on wet pavement as measured under controlled conditions on specified government test surfaces of asphalt and concrete. A tire marked C may have poor traction performance.

## Temperature A B C

### WARNING



The temperature grade for this tire is established for a tire that is properly inflated and not overloaded. Excessive speed, underinflation, or excessive loading, either separately or in combination, can cause heat buildup and possible tire failure.

The temperature grades are A (the highest), B and C, representing the tire's resistance to the generation of heat and its ability to dissipate heat when tested under controlled conditions on a specified indoor laboratory test wheel. Sustained high temperature can cause the material of the tire to degenerate and reduce tire life, and excessive temperature can lead to sudden tire failure. The grade C corresponds to a level of performance which all passenger car tires must meet under the

Federal Motor Vehicle Safety Standard No. 139. Grades B and A represent higher levels of performance on the laboratory test wheel than the minimum required by law.

## Glossary of Tire Terminology

\***Tire label:** A label showing the original equipment tire sizes, recommended inflation pressure and the maximum weight the vehicle can carry.

\***Tire Identification Number:** A number on the sidewall of each tire providing information about the tire brand and manufacturing plant, tire size and date of manufacture. Also referred to as DOT code.

\***Inflation pressure:** A measure of the amount of air in a tire.

\***Standard load:** A class of P-metric or Metric tires designed to carry a maximum load at set pressure. For example: For P-metric tires 35 psi (2.4 bar) and for Metric tires 36 psi (2.5 bar). Increasing the inflation pressure beyond this pressure will not increase the tire's load carrying capability.

\***Extra load:** A class of P-metric or Metric tires designed to carry a heavier maximum load at 42 psi (2.9 bar). Increasing the inflation pressure beyond this pressure will not increase the tire's load carrying capability.

# Wheels and Tires

\***kPa:** Kilopascal, a metric unit of air pressure.

\***PSI:** Pounds per square inch, a standard unit of air pressure.

\***Cold tire pressure:** The tire pressure when the vehicle has been stationary and out of direct sunlight for an hour or more and prior to the vehicle being driven for 1 mile (1.6 kilometers).

\***Recommended inflation pressure:** The cold inflation pressure found on the Safety Compliance Certification Label. See the completed vehicle's owner's manual for the location of the Safety Compliance Certification Label.

\***Bead area of the tire:** Area of the tire next to the rim.

\***Sidewall of the tire:** Area between the bead area and the tread.

\***Tread area of the tire:** Area of the perimeter of the tire that contacts the road when mounted on the vehicle.

\***Rim:** The metal support (wheel) for a tire or a tire and tube assembly upon which the tire beads are seated.

## Information Contained on the Tire Sidewall

Both United States and Canada Federal regulations require tire manufacturers to place standardized information on the sidewall of all tires. This information identifies and describes the fundamental characteristics of the tire and also provides a U.S. DOT Tire Identification Number for safety standard certification and in case of a recall.

## Information on P Type Tires

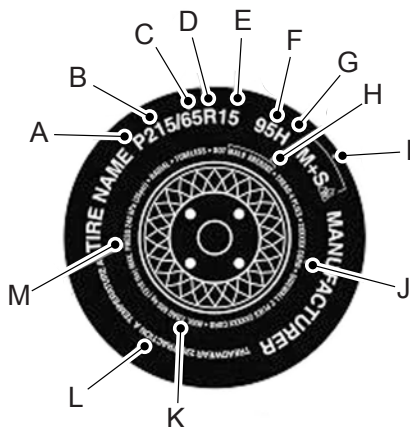

E142543

P215/65R15 95H is an example of a tire size, load index and speed rating. The definitions of these items are listed below. (Note that the tire size, load index and speed rating for your vehicle may be different from this example.)

# Wheels and Tires

A. **P:** Indicates a tire, designated by the Tire and Rim Association, that may be used for service on cars, sport utility vehicles, minivans and light trucks. **Note:** If your tire size does not begin with a letter this may mean it is designated by either the European Tire and Rim Technical Organization or the Japan Tire Manufacturing Association.

B. **215:** Indicates the nominal width of the tire in millimeters from sidewall edge to sidewall edge. In general, the larger the number, the wider the tire.

C. **65:** Indicates the aspect ratio which gives the tire's ratio of height to width.

D. **R:** Indicates a radial type tire.

E. **15:** Indicates the wheel or rim diameter in inches. If you change your wheel size, you will have to purchase new tires to match the new wheel diameter.

F. **95:** Indicates the tire's load index. It is an index that relates to how much weight a tire can carry. You may find this information in your owner's manual. If not, contact a local tire dealer.

**Note:** *You may not find this information on all tires because it is not required by federal law.*

G. **H:** Indicates the tire's speed rating. The speed rating denotes the speed at which a tire is designed to be driven for extended periods of time under a standard condition of load and inflation pressure. The tires on your vehicle may operate at different conditions for load and inflation pressure. These speed ratings may need to be adjusted for the difference in conditions. The ratings range from 81 mph (130 km/h) to 186 mph (299 km/h). These ratings are listed in the following chart.

**Note:** *You may not find this information on all tires because it is not required by federal law.*

Letter rating	Speed rating - mph (km/h)
M	81 (130)
N	87 (140)
Q	99 (159)
R	106 (171)
S	112 (180)
T	118 (190)
U	124 (200)
H	130 (210)
V	149 (240)

## Wheels and Tires

Letter rating	Speed rating - mph (km/h)
W	168 (270)
Y	186 (299)

**Note:** For tires with a maximum speed capability over 149 mph (240 km/h), tire manufacturers sometimes use the letters ZR. For those with a maximum speed capability over 186 mph (299 km/h), tire manufacturers always use the letters ZR.

**H. U.S. DOT Tire Identification Number:** This begins with the letters DOT and indicates that the tire meets all federal standards. The next two numbers or letters are the plant code designating where it was manufactured, the next two are the tire size code and the last four numbers represent the week and year the tire was built. For example, the numbers 317 mean the 31st week of 1997. After 2000 the numbers go to four digits. For example, 2501 means the 25th week of 2001. The numbers in between are identification codes used for traceability. This information is used to contact customers if a tire defect requires a recall.

**I. M+S or M/S:** Mud and Snow, or

**AT:** All Terrain, or

**AS:** All Season.

**J. Tire Ply Composition and Material Used:** Indicates the number of plies or the number of layers of rubber-coated fabric in the tire tread and sidewall. Tire manufacturers also must indicate the ply materials in the tire and the sidewall, which include steel, nylon, polyester, and others.

**K. Maximum Load:** Indicates the maximum load in kilograms and pounds that can be carried by the tire. See the Safety Compliance Certification Label for the correct tire pressure for your vehicle. See the completed vehicle's owner's manual for the location of the Safety Compliance Certification Label.

**L. Treadwear, Traction and Temperature Grades:**

**\*Treadwear** The treadwear grade is a comparative rating based on the wear rate of the tire when tested under controlled conditions on a specified government test course. For example, a tire graded 150 would wear 1½ times as well on the government course as a tire graded 100.

**\*Traction:** The traction grades, from highest to lowest are AA, A, B, and C. The grades represent the tire's ability to stop on wet pavement as measured under controlled conditions on specified government test surfaces of asphalt and concrete. A tire marked C may have poor traction performance.

# Wheels and Tires

**\*Temperature:** The temperature grades are A (the highest), B and C, representing the tire's resistance to the generation of heat and its ability to dissipate heat when tested under controlled conditions on a specified indoor laboratory test wheel.

## M. Maximum Inflation

**Pressure:** Indicates the tire manufacturers' maximum permissible pressure or the pressure at which the maximum load can be carried by the tire. This pressure is normally higher than the vehicle manufacturer's recommended cold inflation pressure which can be found on the Safety Compliance Certification Label. See the completed vehicle's owner's manual for the location of the Safety Compliance Certification Label. The cold inflation pressure should never be set lower than the recommended pressure on the vehicle label.

The tire suppliers may have additional markings, notes or warnings such as standard load or radial tubeless.

## Additional Information Contained on the Tire Sidewall for LT Type Tires

**Note:** *Tire Quality Grades do not apply to this type of tire.*

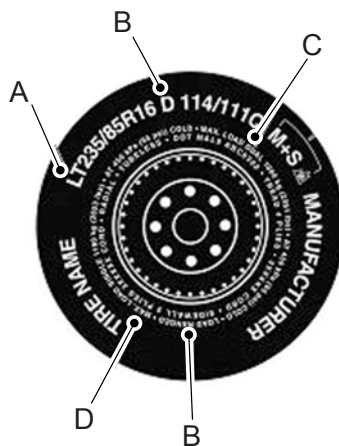

E142544

LT type tires have some additional information beyond those of P type tires; these differences are described below.

**A. LT:** Indicates a tire, designated by the Tire and Rim Association, that is intended for service on light trucks.

**B. Load Range and Load Inflation Limits:** Indicates the tire's load-carrying capabilities and its inflation limits.

**C. Maximum Load Dual lb (kg) at psi (kPa) cold:** Indicates the maximum load and tire pressure when the tire is used as a dual; defined as four tires on the rear axle (a total of six or more tires on the vehicle).

# Wheels and Tires

**D. Maximum Load Single lb (kg) at psi (kPa) cold:** Indicates the maximum load and tire pressure when the tire is used as a single; defined as two tires (total) on the rear axle.

## Information on T Type Tires

T145/80D16 is an example of a tire size.

**Note:** *The temporary tire size for your vehicle may be different from this example. Tire Quality Grades do not apply to this type of tire.*

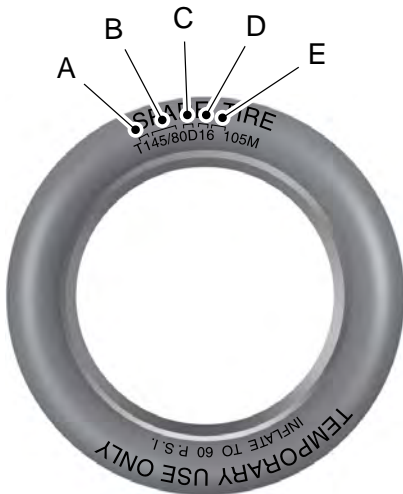

E142545

T type tires have some additional information beyond those of P type tires; these differences are described below:

**A. T:** Indicates a type of tire, designated by the Tire and Rim Association, that is intended for temporary service on cars, sport utility vehicles, minivans and light trucks.

**B. 145:** Indicates the nominal width of the tire in millimeters from sidewall edge to sidewall edge. In general, the larger the number, the wider the tire.

**C. 80:** Indicates the aspect ratio which gives the tire's ratio of height to width. Numbers of 70 or lower indicate a short sidewall.

**D. D:** Indicates a diagonal type tire.

**R:** Indicates a radial type tire.

**E. 16:** Indicates the wheel or rim diameter in inches. If you change your wheel size, you will have to purchase new tires to match the new wheel diameter.

## Inflating Your Tires

Safe operation of your vehicle requires that your tires are properly inflated. Remember that a tire can lose up to half of its air pressure without appearing flat.

Every day before you drive, check your tires. If one looks lower than the others, use a tire gauge to check pressure of all tires and adjust if required.

## Wheels and Tires

---

At least once a month and before long trips, inspect each tire and check the tire pressure with a tire gauge (including spare, if equipped). Inflate all tires to the inflation pressure recommended by Ford Motor Company.

You are strongly urged to buy a reliable tire pressure gauge, as automatic service station gauges may be inaccurate. Ford recommends the use of a digital or dial-type tire pressure gauge rather than a stick-type tire pressure gauge.

Use the recommended cold inflation pressure for optimum tire performance and wear. Under-inflation or over-inflation may cause uneven treadwear patterns

### WARNING



Under-inflation is the most common cause of tire failures and may result in severe tire cracking, tread separation or blowout, with unexpected loss of vehicle control and increased risk of injury. Under-inflation increases sidewall flexing and rolling resistance, resulting in heat buildup and internal damage to the tire. It also may result in unnecessary tire stress, irregular wear, loss of vehicle control and accidents. A tire can lose up to half of its air pressure and not appear to be flat!

---

Always inflate your tires to the Ford recommended inflation pressure even if it is less than the maximum inflation pressure information found on the tire. The Ford recommended tire inflation pressure is found on the Safety Compliance Certification Label or Tire Label. See the completed vehicle's owner's manual for the location of the Safety Compliance Certification Label or Tire Label. Failure to follow the tire pressure recommendations can cause uneven treadwear patterns and adversely affect the way your vehicle handles

**Maximum Inflation Pressure** is the tire manufacturer's maximum permissible pressure and the pressure at which the maximum load can be carried by the tire. This pressure is normally higher than the manufacturer's recommended cold inflation pressure which can be found on the Safety Compliance Certification Label or Tire Label. See the completed vehicle's owner's manual for the location of the Safety Compliance Certification Label or Tire Label. The cold inflation pressure should never be set lower than the recommended pressure on the Safety Compliance Certification Label or Tire Label.

## Wheels and Tires

---

When weather temperature changes occur, tire inflation pressures also change. A 10°F (6°C) temperature drop can cause a corresponding drop of 1 psi (7 kPa) in inflation pressure. Check your tire pressures frequently and adjust them to the proper pressure which can be found on the Safety Compliance Certification Label or Tire Label.

To check the pressure in your tire(s):

1. Make sure the tires are cool, meaning they are not hot from driving even a mile.

**Note:** *If you are checking tire pressure when the tire is hot, (for example, driven more than 1 mile [1.6 kilometers]), never bleed or reduce air pressure. The tires are hot from driving and it is normal for pressures to increase above recommended cold pressures. A hot tire at or below recommended cold inflation pressure could be significantly under-inflated.*

**Note:** *If you have to drive a distance to get air for your tire(s), check and record the tire pressure first and add the appropriate air pressure when you get to the pump. It is normal for tires to heat up and the air pressure inside to go up as you drive.*

2. Remove the cap from the valve on one tire, then firmly press the tire gauge onto the valve and measure the pressure.

3. Add enough air to reach the recommended air pressure.

**Note:** *If you overfill the tire, release air by pressing on the metal stem in the center of the valve. Then recheck the pressure with your tire gauge.*

4. Replace the valve cap.
5. Repeat this procedure for each tire, including the spare.

**Note:** *Some spare tires operate at a higher inflation pressure than the other tires. For T type mini-spare tires, see the Dissimilar spare wheel and tire assembly information for a description. Store and maintain at 60 psi (4.15 bar). For full-size and dissimilar spare tires, see the Dissimilar spare wheel and tire assembly information for a description. Store and maintain at the higher of the front and rear inflation pressure as shown on the Safety Compliance Certification Label or Tire Label.*

6. Visually inspect the tires to make sure there are no nails or other objects embedded that could poke a hole in the tire and cause an air leak.
7. Check the sidewalls to make sure there are no gouges, cuts or bulges.



# Wheels and Tires

## Tire Inflation Information

### WARNING

 An inflated tire and rim can be very dangerous if improperly used, serviced or maintained. To reduce the risk of serious injury, never attempt to re-inflate a tire which has been run flat or seriously under-inflated without first removing the tire from the wheel assembly for inspection. Do not attempt to add air to tires or replace tires or wheels without first taking precautions to protect persons and property.

All tires with Steel Carcass Plies (if equipped):

This type of tire utilizes steel cords in the sidewalls. As such, they cannot be treated like normal light truck tires. Tire service, including adjusting tire pressure, must be performed by personnel trained, supervised and equipped according to Federal Occupational Safety and Health Administration regulations. For example, during any procedure involving tire inflation, the technician or individual must utilize a remote inflation device, and ensure that all persons are clear of the trajectory area.

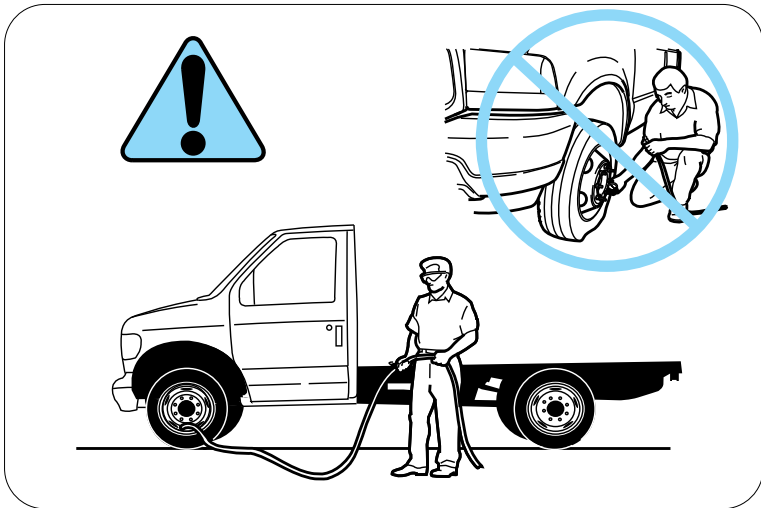

E161437

# Wheels and Tires

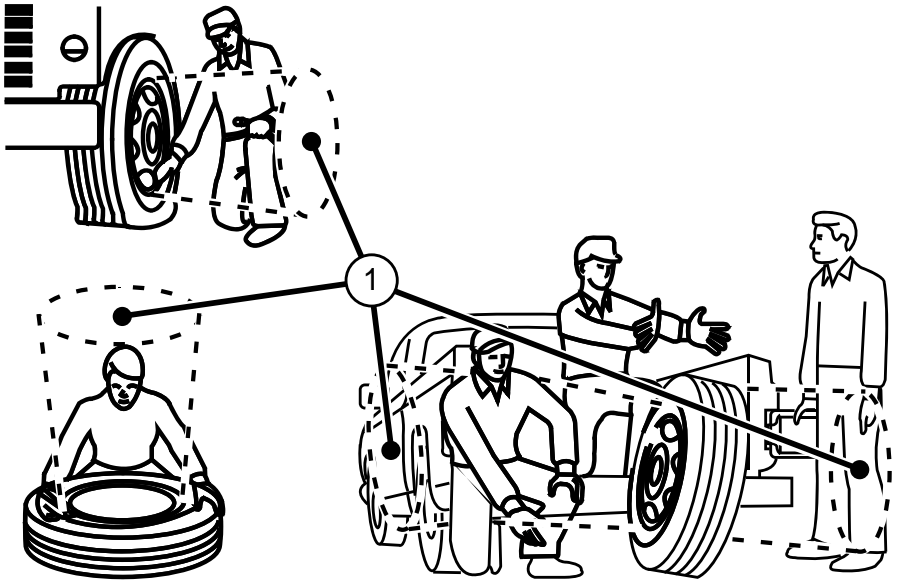

E161438

Stay out of the trajectory (1) as indicated in the illustration.

## Inspecting Your Tires and Wheel Valve Stems

Periodically inspect the tire treads for uneven or excessive wear and remove objects such as stones, nails or glass that may be wedged in the tread grooves. Check the tire and valve stems for holes, cracks, or cuts that may permit air leakage and repair or replace the tire and replace the valve stem. Inspect the tire sidewalls for cracking, cuts, bruises and other signs of damage or excessive

wear. If internal damage to the tire is suspected, have the tire demounted and inspected in case it needs to be repaired or replaced. For your safety, tires that are damaged or show signs of excessive wear should not be used because they are more likely to blow out or fail.

Improper or inadequate vehicle maintenance can cause tires to wear abnormally. Inspect all your tires, including the spare, frequently, and replace them if one or more of the following conditions exist:

# Wheels and Tires

## Tire Wear

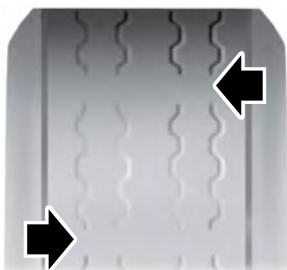

E142546

When the tread is worn down to one sixteenth of an inch (2 millimeters), tires must be replaced to help prevent your vehicle from skidding and hydroplaning. Built-in treadwear indicators, or wear bars, which look like narrow strips of smooth rubber across the tread will appear on the tire when the tread is worn down to one sixteenth of an inch (2 millimeters).

When the tire tread wears down to the same height as these wear bars, the tire is worn out and must be replaced.

## Damage

Periodically inspect the tire treads and sidewalls for damage (such as bulges in the tread or sidewalls, cracks in the tread groove and separation in the tread or sidewall). If damage is observed

or suspected have the tire inspected by a tire professional. Tires can be damaged during off-road use, so inspection after off-road use is also recommended.

## Age

### WARNINGS

 Tires degrade over time depending on many factors such as weather, storage conditions, and conditions of use (load, speed, inflation pressure) the tires experience throughout their lives.

 In general, tires should be replaced after six years regardless of tread wear or even if they have not been used. However, heat caused by hot climates or frequent high-load conditions can accelerate the aging process and may require you to replace tires more frequently.

 You should replace your spare tire when you replace the road tires or after six years due to aging even if it has not been used.

# Wheels and Tires

## U.S. DOT Tire Identification Number

Both United States and Canada Federal regulations require tire manufacturers to place standardized information on the sidewall of all tires. This information identifies and describes the fundamental characteristics of the tire and also provides a U.S. DOT Tire Identification Number for safety standard certification and in case of a recall.

This begins with the letters DOT and indicates that the tire meets all federal standards. The next two numbers or letters are the plant code designating where it was manufactured, the next two are the tire size code and the last four numbers represent the week and year the tire was built. For example, the numbers 317 mean the 31st week of 1997. After 2000 the numbers go to four digits. For example, 2501 means the 25th week of 2001. The numbers in between are identification codes used for traceability. This information is used to contact customers if a tire defect requires a recall.

## Tire Replacement Requirements

Your vehicle is equipped with tires designed to provide a safe ride and handling capability.

## WARNINGS



Only use replacement tires and wheels that are the same size, load index, speed rating and type (such as P-metric versus LT-metric or all-season versus all-terrain) as those originally provided by Ford. The recommended tire and wheel size may be found on either the Safety Compliance Certification Label (affixed to either the door hinge pillar, door-latch post, or the door edge that meets the door-latch post, next to the driver's seating position), or the Tire Label which is located on the B-Pillar or edge of the driver's door. If this information is not found on these labels, then you should contact your authorized dealer as soon as possible. Use of any tire or wheel not recommended by Ford can affect the safety and performance of your vehicle, which could result in an increased risk of loss of vehicle control, vehicle rollover, personal injury and death.





To reduce the risk of serious injury, when mounting replacement tires and wheels, you should not exceed the maximum pressure indicated on the sidewall of the tire to set the beads without additional precautions listed below. If the beads do not seat at the maximum pressure indicated, re-lubricate and try again.

# Wheels and Tires

---

## WARNINGS

 When inflating the tire for mounting pressures up to 20 psi (1.38 bar) greater than the maximum pressure on the tire sidewall, the following precautions must be taken to protect the person mounting the tire:

 1. Make sure that you have the correct tire and wheel size.

 2. Lubricate the tire bead and wheel bead seat area again.

 3. Stand at a minimum of 12 ft (3.66 m) away from the wheel and tire assembly.

 4. Use both eye and ear protection.

 For a mounting pressure more than 20 psi (1.38 bar) greater than the maximum pressure, a Ford dealer or other tire service professional should do the mounting.

 Always inflate steel carcass tires with a remote air fill with the person inflating standing at a minimum of 12 ft (3.66 m) away from the wheel and tire assembly.

---

**Important:** Remember to replace the wheel valve stems when the road tires are replaced on your vehicle

It is recommended that the two front tires or two rear tires generally be replaced as a pair.

## Replacing a Tire That is Greenhouse Gas Certified

The tires installed on this vehicle at the factory as original equipment are certified for Greenhouse Gas and Fuel Efficiency regulations. Replacement tires must be of equal or lower rolling resistance level (TRRL or Crr). Consult with your tire supplier(s) for appropriate replacement tires.

## Safety Practices

### WARNINGS

 If your vehicle is stuck in snow, mud or sand, do not rapidly spin the tires; spinning the tires can tear the tire and cause an explosion. A tire can explode in as little as three to five seconds.

 Do not spin the wheels at over 34 mph (55 km/h). The tires may fail and injure a passenger or bystander.

---

**Driving habits have a great deal to do with your tire mileage and safety.**

- \*Observe posted speed limits
- \*Avoid fast starts, stops and turns
- \*Avoid potholes and objects on the road
- \*Do not run over curbs or hit the tire against a curb when parking

# Wheels and Tires

---

## Highway Hazards

No matter how carefully you drive there's always the possibility that you may eventually have a flat tire on the highway. Drive slowly to the closest safe area out of traffic. This may further damage the flat tire, but your safety is more important.

If you feel a sudden vibration or ride disturbance while driving, or you suspect your tire or vehicle has been damaged, immediately reduce your speed. Drive with caution until you can safely pull off the road. Stop and inspect the tires for damage. If a tire is under-inflated or damaged, deflate it, remove wheel and replace it with your spare tire and wheel. If you cannot detect a cause, have the vehicle towed to the nearest repair facility or tire dealer to have the vehicle inspected.

## Tire and Wheel Alignment

A bad jolt from hitting a curb or pothole can cause the front end of your vehicle to become misaligned or cause damage to your tires. If your vehicle seems to pull to one side when you're driving, the wheels may be out of alignment. Have an authorized dealer check the wheel alignment periodically.

Wheel misalignment in the front or the rear can cause uneven and rapid treadwear of your tires and should be corrected by an authorized dealer. Front-wheel drive vehicles and those with an independent rear suspension may require alignment of all four wheels.

The tires should also be balanced periodically. An unbalanced tire and wheel assembly may result in irregular tire wear.

## Tire Rotation

**Note:** *If your tires show uneven wear ask an authorized dealer to check for and correct any wheel misalignment, tire imbalance or mechanical problem involved before tire rotation.*

**Note:** *Your vehicle may be equipped with a dissimilar spare wheel and tire assembly. A dissimilar spare wheel and tire assembly is defined as a spare wheel and tire assembly that is different in brand, size or appearance from the road tires and wheels. If you have a dissimilar spare wheel and tire assembly it is intended for temporary use only and should not be used in a tire rotation.*

**Note:** *After having your tires rotated, inflation pressure must be checked and adjusted to the vehicle requirements.*

# Wheels and Tires

Rotating your tires at the recommended interval (as indicated in the Scheduled Maintenance chapter) will help your tires wear more evenly, providing better tire performance and longer tire life.

Dual rear wheel drive vehicle - six tire rotation

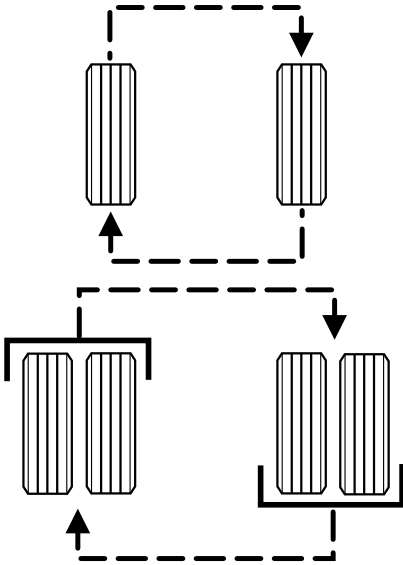

E161439

If your vehicle is equipped with dual rear wheels it is recommended that the front and rear tires (in pairs) be rotated only side to side. We do not recommend splitting up the dual

rear wheels. Rotate them side to side as a set. After tire rotation, inflation pressures must be adjusted for the tires new positions in accordance with vehicle requirements.

Sometimes irregular tire wear can be corrected by rotating the tires.

## USING SNOW CHAINS

### WARNING

 Snow tires must be the same size, load index, and speed rating as those originally provided by Ford. Use of any tire or wheel not recommended by Ford can affect the safety and performance of your vehicle, which could result in an increased risk of loss of vehicle control, vehicle rollover, personal injury, and death. Additionally, the use of non-recommended tires and wheels could cause steering, suspension, axle, transfer case, or power transfer unit failure. It is also strongly advised to follow the Ford recommended tire inflation pressure found on the Safety Compliance Certification Label (affixed to either the door hinge pillar, door-latch post, or the door edge that meets the door-latch post, next to the driver's seating position), or Tire Label which is located on the B-Pillar or the edge of the driver door. Failure to follow the tire pressure recommendations can cause uneven treadwear patterns and adversely affect the way your vehicle handles.

The tires on your vehicle have all-weather treads to provide traction in rain and snow. However, in some climates, you may need to use snow tires and cables. If you need to use cables, it is recommended that steel wheels (of the same size and specifications) be used, as cables may chip aluminum wheels.

# Wheels and Tires

**Note:** *The suspension insulation and bumpers help prevent vehicle damage. Do not remove these components from your vehicle when using snow tires and chains.*

Follow these guidelines when using snow tires and chains:

- If possible, avoid fully loading your vehicle.
- Use only SAE Class S chains.
- Install chains securely, verifying that the chains do not touch any wiring, brake lines or fuel lines.
- Drive cautiously. If you hear the chains rub or bang against your vehicle, stop and retighten the chains. If this does not work, remove the chains to prevent damage to your vehicle.
- Remove the tire chains when they are no longer needed. Do not use tire chains on dry roads.

If you have any questions regarding snow chains or cables, please contact your authorized dealer.

## CHANGING A ROAD WHEEL

If you get a flat tire while driving, do not apply the brake heavily. Instead, gradually decrease your speed. Hold the steering wheel firmly and slowly move to a safe place on the side of the road.

### Dissimilar Spare Wheel and Tire Assembly Information

#### WARNING



Failure to follow these guidelines could result in an increased risk of loss of vehicle control, injury or death.

If you have a dissimilar spare wheel and tire, then it is intended for temporary use only. This means that if you need to use it, you should replace it as soon as possible with a road wheel and tire assembly that is the same size and type as the road tires and wheels that were originally provided by Ford. If the dissimilar spare tire or wheel is damaged, it should be replaced rather than repaired.

A dissimilar spare wheel and tire assembly is defined as a spare wheel and tire assembly that is different in brand, size or appearance from the road tires and wheels and can be one of three types:

1. **T-type mini-spare:** This spare tire begins with the letter T for tire size and may have Temporary Use Only molded in the sidewall.
2. **Full-size dissimilar spare with label on wheel:** This spare tire has a label on the wheel that states: THIS WHEEL AND TIRE ASSEMBLY FOR TEMPORARY USE ONLY.

When driving with one of the dissimilar spare tires listed above, do not:

- Exceed 50 mph (80 km/h).
- Load the vehicle beyond maximum vehicle load rating listed on the Safety Compliance Label.
- Tow a trailer.
- Use snow chains on the end of the vehicle with the dissimilar spare tire.
- Use more than one dissimilar spare tire at a time.
- Use commercial car washing equipment.
- Try to repair the dissimilar spare tire.



# Wheels and Tires

Use of one of the dissimilar spare tires listed above at any one wheel location can lead to impairment of the following:

- Handling, stability and braking performance.
- Comfort and noise.
- Ground clearance and parking at curbs.
- Winter weather driving capability.
- Wet weather driving capability.
- All-wheel driving capability.

### 3. Full-size dissimilar spare without label on wheel

When driving with the full-size dissimilar spare wheel and tire assembly, do not:

- Exceed 70 mph (113 km/h).
- Use more than one dissimilar spare wheel and tire assembly at a time.
- Use commercial car washing equipment.
- Use snow chains on the end of the vehicle with the dissimilar spare wheel and tire assembly.

The usage of a full-size dissimilar spare wheel and tire assembly can lead to impairment of the following:

- Handling, stability and braking performance.
- Comfort and noise.
- Ground clearance and parking at curbs.
- Winter weather driving capability.
- Wet weather driving capability.
- All-wheel driving capability.

When driving with the full-size dissimilar spare wheel and tire assembly additional caution should be given to:

- Towing a trailer.
- Driving vehicles equipped with a camper body.
- Driving vehicles with a load on the cargo rack.

Drive cautiously when using a full-size dissimilar spare wheel and tire assembly and seek service as soon as possible.

## Tire Change Procedure

### WARNINGS



When one of the front wheels is off the ground, the transmission alone will not prevent the vehicle from moving or slipping off the jack, even if the transmission is in park (P).



To help prevent the vehicle from moving when you change a tire, be sure to place the transmission in park (P), set the parking brake and block (in both directions) the wheel that is diagonally opposite (other side and end of the vehicle) to the tire being changed.



Never get underneath a vehicle that is supported only by a jack. If the vehicle slips off the jack, you or someone else could be seriously injured.



Do not attempt to change a tire on the side of the vehicle close to moving traffic. Pull far enough off the road to avoid the danger of being hit when operating the jack or changing the wheel.



Always use the jack provided as original equipment with your vehicle. If using a jack other than the one provided as original equipment with your vehicle, make sure the jack capacity is adequate for the vehicle weight, including any vehicle cargo or modifications.

1. Park on a level surface, set the parking brake and activate the hazard flashers.
2. Place the transmission in park (P) and turn the engine off.

# Wheels and Tires

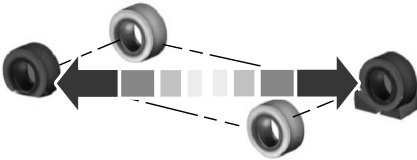

E175447

3. Block the diagonally opposite wheel. The parking brake is on the transmission. Therefore, the vehicle will not be prevented from moving when a rear wheel is lifted, even if the parking brake is applied. Be sure to block both directions of the wheel that is diagonally opposite to the wheel that is being lifted.
4. Remove the spare tire and jack from the storage location.
5. Loosen the wheel nut by pulling up on the handle of the lug nut wrench about one-half turn (counterclockwise). Do not remove the wheel lug nuts until you raise the tire off the ground.
6. Position the jack to raise the front or rear wheel. Raise the vehicle with the jack applied to the axle(s).

**Note:** *Never use the rear differential as a jacking point.*

7. Raise the vehicle until the wheel is completely off the ground.
8. Remove the lug nuts with the lug nut wrench.
9. Replace the flat tire with the spare tire.

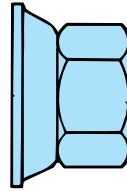

E161440

10. Use the lug nut wrench to screw the lug nut snugly against the wheel.
11. Lower the vehicle.
12. Remove the jack and fully tighten the lug nuts in the order shown. See **Technical Specifications** (page 128).



E161441

8-lug nut wheel



E169375

10-lug nut wheel

13. Replace any wheel trim.

# Wheels and Tires

14. Stow the jack, handle and lug wrench.
15. Unblock the wheels.

## TECHNICAL SPECIFICATIONS

### Wheel Lug Nut Torque Specifications

#### WARNING



When you install a wheel, always remove any corrosion, dirt or foreign materials present on the mounting surfaces of the wheel or the surface of the wheel hub, brake drum or brake disc that contacts the wheel. Make sure to secure any fasteners that attach the rotor to the hub so they do not interfere with the mounting surfaces of the wheel. Installing wheels without correct metal-to-metal contact at the wheel mounting surfaces can cause the wheel nuts to loosen and the wheel to come off while your vehicle is in motion, resulting in loss of vehicle control, personal injury or death.

Bolt size	lb-ft (Nm)*
M14 x 1.5 (19.5 inch wheels)	150 (200)
M22 x 1.5 (22.5 inch wheels)	450 (610)

\*Torque specifications are for nut and bolt threads free of dirt and rust. Use only Ford recommended replacement fasteners.

On vehicles equipped with dual rear wheels, retighten the wheel lug nuts to the specified torque at 100 miles (160 kilometers), and again at 500 miles (800 kilometers) of new vehicle operation and after any wheel disturbance (such as tire rotation, changing a flat tire, wheel removal).

On all two-piece flat wheel nuts, apply one drop of motor oil between the flat washer and the nut. Do not apply motor oil to the wheel nut threads or the wheel stud threads.



E161443

# Capacities and Specifications

## ENGINE SPECIFICATIONS

Engine	6.8L Engine
Displacement	415 in <sup>3</sup> (6,800 cm <sup>3</sup> )
Firing order	1-6-5-10-2-7-3-8-4-9
Ignition system	Coil on plug
Spark plug gap	0.039 in (1 mm) - 0.043 in (1.1 mm)
Compression ratio	9.2:1

### Drivebelt Routing

#### Engines with Air Conditioning



E270433

#### Engines without Air Conditioning



E270434

## MOTORCRAFT PARTS

Component	Motorcraft Part number
Air filter element	FA-1782
Battery (F-53 stripped chassis and F-59 step van ramp prep package)	BH-31-XT
Battery (F-59 step van)	BH-31-XT
Oil filter	FL-820-S

## Capacities and Specifications

---

Component	Motorcraft Part number
Spark plugs	SP-509
Transmission fluid filter	FT-187

We recommend Motorcraft replacement parts available at your Ford dealer or at [fordparts.com](http://fordparts.com) for scheduled maintenance. These parts meet or exceed Ford Motor Company's specifications and are engineered for your vehicle. Use of other parts may impact vehicle performance, emissions and durability. Your warranty may be void for any damage related to use of other parts.

If a Motorcraft oil filter is not available, use an oil filter that meets industry performance specification SAE/USCAR-36.

For spark plug replacement, contact an authorized dealer. Replace spark plugs at the appropriate intervals. See **Scheduled Maintenance** (page 140).

# Capacities and Specifications

## VEHICLE IDENTIFICATION NUMBER

The vehicle identification number is on the back of the steering member at one of the following locations.

**Note:** *The body builder will include an additional VIN tag that could be on the driver side of the dash, the A pillar, or in the area of the driver door.*

### Motorhome Chassis

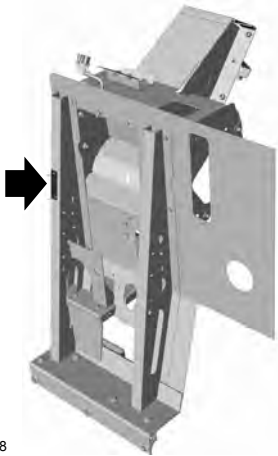

E251918

### Commercial Chassis

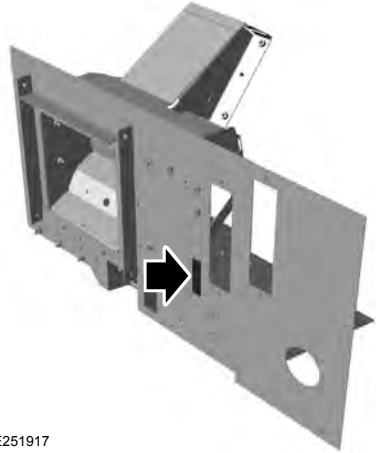

E251917

If you ever find it necessary to communicate with Ford Motor Company about your vehicle, always include the VIN in your communication. The Vehicle Identification Number (VIN) contains the following information:

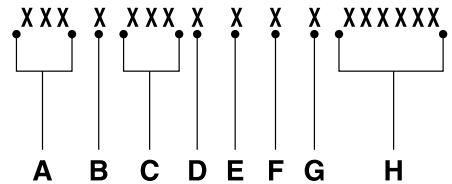

E142477

- A World manufacturer identifier
- B Brake system, Gross Vehicle Weight Rating, Restraint Devices and their locations

# Capacities and Specifications

- C Make, vehicle line, series, body type
- D Engine type
- E Check digit
- F Model year
- G Assembly plant
- H Production sequence number

The National Highway Traffic Safety Administration Regulations require that a Safety Compliance Certification Label be affixed to a vehicle and prescribe where the Safety Compliance Certification Label may be located. The Safety Compliance Certification Label shall be affixed to either the door hinge pillar, the door latch post, or the edge of the door near the door latch, next to the driver's seating position.

## VEHICLE CERTIFICATION LABEL

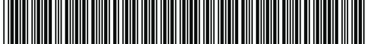
MFD. BY FORD MOTOR CO.			
DATE: XX/XX	GVWR: XXXX KG (XXXX LB)		
FRONT GAWR:	WITH	REAR GAWR:	WITH
XXXX KG (XXXX LB)	TIRES	XXXX KG (XXXX LB)	TIRES
XXXXXXXXXXXXXXXXXX		XXXXXXXXXXXXXXXXXX	
XXXXXX	RIMS	XXXXXX	RIMS
AT XXXX kPa/ XXX	PSI COLD	AT XXXX kPa/ XXX	PSI COLD
THIS VEHICLE CONFORMS TO ALL APPLICABLE FEDERAL MOTOR VEHICLE SAFETY AND THEFT PREVENTION STANDARDS IN EFFECT ON THE DATE OF MANUFACTURE SHOWN ABOVE.			
VIN: XXXXXXXXXXXXXXXXXXXX		XXXXX	XXXXX
TYPE: XXXX			
			
EXT PNT: XX	XXXXXX	IRC: XX	DSO: XXXX
WB	INT TR	TP/PS	R AXLE
TR	SPR	XXXX	XXXX
XXX	XX	XXX	X XX X XXXX XXXX
		XXXXXXXXXXXXXX	XXX XXXX-XXXXXXX-XX

E167469

## TRANSMISSION CODE DESIGNATION

MFD. BY FORD MOTOR CO.			
DATE: XX/XX	GVWR: XXXX KG (XXXX LB)		
FRONT GAWR:	WITH	REAR GAWR:	WITH
XXXX KG (XXXX LB)	TIRES	XXXX KG (XXXX LB)	TIRES
XXXXXXXXXXXXXXXXXX		XXXXXXXXXXXXXXXXXX	
XXXXXX	RIMS	XXXXXX	RIMS
AT XXXX kPa/ XXX	PSI COLD	AT XXXX kPa/ XXX	PSI COLD
THIS VEHICLE CONFORMS TO ALL APPLICABLE FEDERAL MOTOR VEHICLE SAFETY AND THEFT PREVENTION STANDARDS IN EFFECT ON THE DATE OF MANUFACTURE SHOWN ABOVE.			
VIN: XXXXXXXXXXXXXXXXXXXX		XXXXX	XXXXX
TYPE: XXXX			
			
EXT PNT: XX	XXXXXX	IRC: XX	DSO: XXXX
WB	INT TR	TP/PS	R AXLE
TR	SPR	XXXX	XXXX
XXX	XX	XXX	X XX X XXXX XXXX
		XXXXXXXXXXXXXX	XXX XXXX-XXXXXXX-XX

E167814

The transmission code is on the Safety Compliance Certification Label. The following table shows the transmission code along with the transmission description.

Description	Code
Six Speed Automatic Transmission (6R140)	P

# Capacities and Specifications

## CAPACITIES AND SPECIFICATIONS

### Capacities

#### WARNING



The air conditioning refrigerant system contains refrigerant under high pressure. Only qualified personnel should service the air conditioning refrigerant system. Opening the air conditioning refrigerant system can cause personal injury.

Item	Capacity
Engine oil (with oil filter)	7.0 qt (6.6 L)
Engine coolant	30.6 qt (29 L)
Brake fluid	Between MIN/MAX on brake fluid reservoir
Rear axle lubricant (Dana M80 axle)	4.1 qt (3.9 L)
Rear axle lubricant (Dana S110 axle)	8.0 qt (7.6 L)
Rear axle lubricant (Dana S130 axle)	7.0 qt (6.6 L)
Rear axle lubricant (Dana Spicer 107060S axle)	16.0 qt (15.1 L)
Automatic transmission fluid	17.2 qt (16.3 L) <sup>1</sup>
Power steering fluid	Keep in FULL range on dipstick
Windshield washer fluid	Fill as required
Fuel tank (Motorhome)	80 gal (303 L)
Fuel tank (Commercial chassis)	40 gal (151 L)
A/C refrigerant	44 oz (1.25 kg)
A/C refrigerant compressor oil	8.8 fl oz (260.2 ml)

<sup>1</sup> Approximate dry fill capacity. Actual amount may vary during fluid changes.



# Capacities and Specifications

## Specifications

### Materials

Name	Specification
Motor oil (U.S.): Motorcraft® SAE 5W-30 Premium Synthetic Blend Motor Oil XO-5W30-QSP	WSS-M2C946-A
Motor oil (Canada): Motorcraft® SAE 5W-30 Super Premium Motor Oil CXO-5W30-LSP12	WSS-M2C946-A
Engine coolant (U.S.): Motorcraft® Orange Prediluted Antifreeze/Coolant VC-3DIL-B	WSS-M97B44-D2
Engine coolant (Canada): Motorcraft® Orange Prediluted Antifreeze/Coolant CVC-3DIL-B	WSS-M97B44-D2
Brake fluid (U.S.): Motorcraft® High Performance DOT 3 Motor Vehicle Brake Fluid PM-1-C	WSS-M6C65-A1 <sup>1</sup>
Brake fluid (Canada): Motorcraft® High Performance DOT 3 Motor Vehicle Brake Fluid CPM-1-C	WSS-M6C65-A1 <sup>1</sup>
Brake fluid: Motorcraft® DOT 5.1 Motor Vehicle Brake Fluid PM-21	WSS-M6C65-A3 <sup>2</sup>
Rear axle lubricant (U.S.): Motorcraft® SAE 75W-140 Synthetic Rear Axle Lubricant XY-75W140-QL	WSL-M2C192-A
Rear axle lubricant (Canada): Motorcraft® SAE 75W-140 Synthetic Rear Axle Lubricant CXY-75W140-1L	WSL-M2C192-A
Automatic transmission fluid and power steering fluid (U.S.): Motorcraft® MERCON® LV Automatic Transmission Fluid XT-10-QLVC	WSS-M2C938-A MERCON® LV

## Capacities and Specifications

Name	Specification
Automatic transmission fluid and power steering fluid (Canada): Motorcraft® MERCON® LV Automatic Transmission Fluid CXT-10-LV12	WSS-M2C938-A MERCON® LV
Windshield washer fluid (U.S.): Motorcraft® Premium Windshield Wash Concentrate with Bitterant ZC-32-B2	WSS-M14P19-A
Windshield washer fluid (Canada): Motorcraft® Premium Quality Windshield Washer Fluid CXC-37-(A, B, D, F)	WSS-M14P19-A
A/C refrigerant (U.S.): Motorcraft® R-134a Refrigerant YN-19	WSH-M17B19-A
A/C refrigerant (Canada): Motorcraft® R-134a Refrigerant CYN-16-R	WSH-M17B19-A
A/C refrigerant compressor oil: Motorcraft® PAG Refrigerant Compressor Oil YN-12-D	WSH-M1C231-B
Transmission, steering, parking linkages and pivots and brake pedal shaft grease: Premium Long-Life Grease XG-1-E1	ESA-M1C75-B
Multi-purpose grease: Motorcraft® Multi-Purpose Grease Spray XL-5-A	ESB-M1C93-B

<sup>1</sup> Motorcraft® DOT 3 High Performance Motor Vehicle Brake Fluid is for vehicles with Hydroboost brake booster systems. This include chassis with gross vehicle weight ratings of 16,000 lb (7257 kg), 18,000 lb (8165 kg) and 19,500 lb (8845 kg).

<sup>2</sup> Motorcraft® DOT 5.1 Motor Vehicle Brake Fluid is for vehicles with Hydromax brake booster systems. This includes chassis with gross vehicle weight ratings of 19,500 lb (8845 kg), 20,500 lb (9299 kg), 22,000 lb (9979 kg), 24,000 lb (10886 kg) and 26,000 lb (11793 kg).

# Capacities and Specifications

If you use oil and fluids that do not meet the defined specification and viscosity grade, this may lead to:

- Component damage which is not covered by the vehicle warranty.
- Longer engine cranking periods.
- Increased emission levels.
- Reduced engine performance.
- Reduced fuel economy.
- Degraded brake performance.

We recommend Motorcraft® motor oil for your vehicle. If Motorcraft® oil is not available, use motor oils of the recommended viscosity grade that meet API SN requirements and display the API Certification Mark for gasoline engines. Do not use oil labeled with API SN service category unless the label also displays the API certification mark.



E142732

## Materials

Name	Specification
Motorcraft® SAE 0W-30 Premium Synthetic Blend Motor Oil: Engine Oil - SAE 0W-30 XO-0W30-QSP	WSS-M2C953-A1

An oil that displays this symbol conforms to current engine, emission system and fuel economy performance standards of ILSAC.

Do not use supplemental engine oil additives because they are unnecessary and could lead to engine damage that may not be covered by your vehicle warranty.

**Note:** *Ford recommends using DOT 3 High Performance Brake Fluid or equivalent meeting WSS-M6C65-A1 or DOT 5.1 Motor Vehicle Brake Fluid WSS-M6C65-A3. Use of any fluid other than the recommended fluid may cause degraded brake performance and not meet the Ford performance standards. Keep brake fluid clean and dry. Contamination with dirt, water, petroleum products or other materials may result in brake system damage and possible failure.*

**Note:** *Automatic transmissions that require MERCON® LV transmission fluid should only use MERCON® LV transmission fluid. The use of any other fluid may cause transmission damage.*

## Alternative Engine Oil for Extremely Cold Climates

To improve engine cold start performance, we recommend that you use the following alternative engine oil in extremely cold climates, where the ambient temperature reaches  $-22.0^{\circ}\text{F}$  ( $-30^{\circ}\text{C}$ ) or below.

# Capacities and Specifications

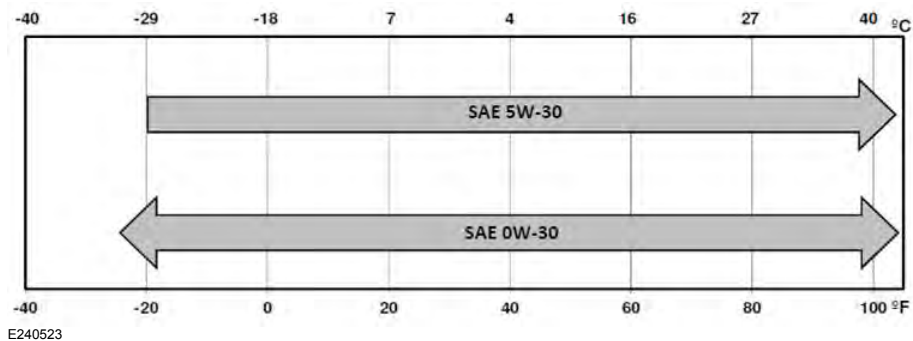

# Ford Protect

---

PROTECT YOURSELF FROM THE RISING COST OF VEHICLE REPAIRS WITH A FORD PROTECT EXTENDED SERVICE PLAN.

## **Ford Protect Extended Service Plans (U.S. Only)**

Ford Protect extended service plan means peace of mind. It's the extended service plan backed by Ford Motor Company, and provides more protection beyond the New Vehicle Limited Warranty coverage. When you visit your Ford Dealer, Insist on Ford Protect extended service plans!

## **Ford Protect Can Quickly Pay for Itself**

One trip to the Service Center could easily exceed the price of your Ford Protect extended service plan. With Ford Protect extended service plan you minimize your risk for unexpected repair bills and rising repair costs.

## **Up to 1,000+ Covered Vehicle Components**

There are four mechanical Ford Protect extended service plans with different levels of coverage. Ask your authorized dealer for details.

1. PremiumCARE - Our most comprehensive coverage. With over 1,000 covered components, this plan is so complete it's probably easier to list what's not covered.
2. ExtraCARE - Covers 113 components, and includes many high-tech items.
3. BaseCARE - Covers 84 components.
4. PowertrainCARE - Covers 29 critical components.

Ford Protect extended service plans are honored by all authorized Ford dealers in the U.S., Canada and Mexico.

That means you get:

- Reliable, quality service at any Ford or Lincoln dealership.
- Repairs performed by factory trained technicians, using genuine parts.

## **Rental Car Reimbursement**

### ***1st day Rental Benefit***

If you bring your car into your dealer for service, we'll give you a loaner to use for the day.

### ***Extended Rental Benefits***

If your vehicle is kept overnight for covered repairs, you are eligible for rental car coverage, including warranty repairs, and Field Service Actions.

## **Roadside Assistance**

Exclusive 24/7 roadside assistance, including:

- Towing, flat-tire change and battery jump starts.
- Out of fuel and lock-out assistance.
- Travel expense reimbursement for lodging, meals and rental car.
- Assistance for taxi, shuttle, rental car coverage or other transportation.

## **Transferable Coverage**

If you sell your vehicle before your Ford Protect extended service plan coverage expires, you can transfer any remaining coverage to the new owner. Which should give you and your potential buyer a little more peace of mind.

# Ford Protect

---

## Less Cost to Properly Maintain Your Vehicle

Ford Protect extended service plan also offers a Premium Maintenance Plan that covers all scheduled maintenance, and selected wear items. The coverage is prepaid, so you never have to worry about the cost of your vehicle's maintenance.

Covered maintenance includes:

- Windshield wiper blades.
- Spark plugs.
- The clutch disc (if equipped).
- Brake pads and linings.
- Shock absorbers.
- Struts.
- Engine Belts.
- Engine coolant hoses, clamps and o-rings.
- Diesel exhaust fluid replenishment (if equipped).
- Cabin air filter replacement every 20,000 mi (32,000 km) (electric vehicles only).

## Interest Free Finance Options

Just a 10% down payment will provide you with an affordable, no interest, no fee payment program allowing you all the security and benefits Ford Protect extended service plan has to offer while paying over time. You are pre-approved with no credit check or hassles. To learn more, call our Ford Protect extended service plan specialists at 800-367-3377.

Ford Protect Extended Service Plan  
P.O. Box 321067  
Detroit, MI 48232

## Ford Protect Extended Service Plan (CANADA ONLY)

You can get more protection for your vehicle by purchasing a Ford Protect extended service plan. Ford Protect extended service plan is the only service contract backed by Ford Motor Company of Canada, Limited. Depending on the plan you purchase, Ford Protect extended service plan provides benefits such as:

- Rental reimbursement.
- Coverage for certain maintenance and wear items.
- Protection against repair costs after your New Vehicle Limited Warranty Coverage expires.
- Roadside Assistance benefits.

There are several Ford Protect extended service plans available in various time, distance and deductible combinations. Each plan is tailored to fit your own driving needs, including reimbursement for towing and rental. When you purchase Ford Protect extended service plan, you receive added peace-of-mind protection throughout Canada, the United States and Mexico, provided by a network of participating authorized Ford Motor Company dealers.

**Note:** *Repairs performed outside of Canada, the United States and Mexico are not eligible for Ford Protect extended service plan coverage.*

This information is subject to change. For more information; visit your local Ford of Canada dealer or [www.ford.ca](http://www.ford.ca) to find the Ford Protect extended service plan that is right for you.

# Scheduled Maintenance

---

## GENERAL MAINTENANCE INFORMATION

### Why Maintain Your Vehicle?

Carefully following the maintenance schedule helps protect against major repair expenses resulting from neglect or inadequate maintenance and may help to increase the value of your vehicle when you sell or trade it. Keep all receipts for completed maintenance with your vehicle.

We have established regular maintenance intervals for your vehicle based upon rigorous testing. It is important that you have your vehicle serviced at the proper times. These intervals serve two purposes; one is to maintain the reliability of your vehicle and the second is to keep your cost of owning your vehicle down.

It is your responsibility to have all scheduled maintenance performed and to make sure that the materials used meet the specifications identified in this owner's manual. See **Capacities and Specifications** (page 129).

Failure to perform scheduled maintenance invalidates warranty coverage on parts affected by the lack of maintenance.

### Why Maintain Your Vehicle at Your Dealership?

#### Factory-trained Technicians

Service technicians participate in extensive factory-sponsored certification training to help them become experts on the operation of your vehicle. Ask your dealership about the training and certification their technicians have received.

### Genuine Ford and Motorcraft Replacement Parts

Dealerships stock Ford, Motorcraft and Ford-authorized branded re-manufactured replacement parts. These parts meet or exceed our specifications. Parts installed at your dealership carry a nationwide 24-month or unlimited mile (kilometer) parts and labor limited warranty.

If you do not use Ford authorized parts they may not meet our specifications and depending on the part, it could affect emissions compliance.

### Convenience

Many dealerships have extended evening and Saturday hours to make your service visit more convenient and they offer one stop shopping. They can perform any services that are required on your vehicle, from general maintenance to collision repairs.

**Note:** *Not all dealers have extended hours or body shops. Please contact your dealer for details.*

### Protecting Your Investment

Maintenance is an investment that pays dividends in the form of improved reliability, durability and resale value. To maintain the proper performance of your vehicle and its emission control systems, make sure you have scheduled maintenance performed at the designated intervals.

Your vehicle is very sophisticated and built with multiple, complex, performance systems. Every manufacturer develops these systems using different specifications and performance features. That is why it is important to rely upon your dealership to properly diagnose and repair your vehicle.

# Scheduled Maintenance

Ford Motor Company has recommended maintenance intervals for various parts and component systems based upon engineering testing. Ford Motor Company relies upon this testing to determine the most appropriate mileage for replacement of oils and fluids to protect your vehicle at the lowest overall cost to you and recommends against maintenance schedules that deviate from the scheduled maintenance information.

We strongly recommend the use of only genuine Ford, Motorcraft or Ford-authorized re-manufactured replacement parts engineered for your vehicle.

## Additives and Chemicals

This owner's manual and the Ford Workshop Manual list the recommended additives and chemicals for your vehicle. We do not recommend using chemicals or additives not approved by us as part of your vehicle's normal maintenance. Please consult your warranty information.

## Oils, Fluids and Flushing

In many cases, fluid discoloration is a normal operating characteristic and, by itself, does not necessarily indicate a concern or that the fluid needs to be changed. However, a qualified expert, such as the factory-trained technicians at your dealership, should inspect discolored fluids that also show signs of overheating or foreign material contamination immediately.

Make sure to change your vehicle's oils and fluids at the specified intervals or in conjunction with a repair. Flushing is a viable way to change fluid for many vehicle sub-systems during scheduled maintenance. It is critical that systems are flushed only with new fluid that is the same as that required to fill and operate the system or using a Ford-approved flushing chemical.

## Owner Checks and Services

Make sure you perform the following basic maintenance checks and inspections every month or at six-month intervals.

<b>Check every month</b>
Engine oil level.
Function of all interior and exterior lights.
Tires (including spare) for wear and proper pressure.
Windshield washer fluid level.

<b>Check every six months</b>
Battery connections. Clean if necessary.
Body and door drain holes for obstructions. Clean if necessary.
Cooling system fluid level and coolant strength.
Door weatherstrips for wear. Lubricate if necessary.



# Scheduled Maintenance

<b>Check every six months</b>
Hinges, latches and outside locks for proper operation. Lubricate if necessary.
Parking brake for proper operation.
Safety belts and seat latches for wear and function.
Safety warning lamps (brake, ABS, airbag and safety belt) for operation.
Washer spray and wiper operation. Clean or replace blades as necessary.

## Multi-point Inspection

In order to keep your vehicle running right, it is important to have the systems on your vehicle checked regularly. This can help identify potential issues and prevent major problems. We recommend having the following multi-point inspection performed at every scheduled maintenance interval to help make sure your vehicle keeps running great.

<b>Multi-point inspection</b>	
Accessory drive belt(s)	Horn operation
Battery performance	Radiator, cooler, heater and A/C hoses
Engine air filter	Suspension component for leaks or damage
Exhaust system	Steering and linkage
Exterior lamps and hazard warning system operation	Tires (including spare) for wear and proper pressure**
Fluid levels*; fill if necessary	Windshield for cracks, chips or pits
For oil and fluid leaks	Washer spray and wiper operation

\* Brake, coolant recovery reservoir, automatic transmission, power steering and window washer.

\*\*If your vehicle is equipped with a temporary mobility kit, check the tire sealant expiration Use By date on the canister. Replace as needed.

# Scheduled Maintenance

Be sure to ask your dealership service advisor or technician about the multi-point vehicle inspection. It is a comprehensive way to perform a thorough inspection of

your vehicle. Your checklist gives you immediate feedback on the overall condition of your vehicle.

## NORMAL SCHEDULED MAINTENANCE

### Every 7500 miles (12000 km) or six months (whichever comes first)

Change engine oil and filter.
Rotate tires*, inspect tire wear and measure tread depth.
Inspect wheels and related components for abnormal noise, wear, looseness or drag.
Perform multi-point inspection (recommended).

\* Vehicles with dual rear wheels should rotate the front wheels when specified; rear wheels only if unusual wear is noted.

### Every 15000 miles (24000 km) or 12 months (whichever comes first)

Inspect automatic transmission fluid level. Consult dealer for requirements.
Inspect brake pads, shoes, rotors, drums, brake linings, hoses and parking brake.
Inspect engine cooling system strength and hoses.
Inspect exhaust system and heat shields.
Inspect steering linkage, ball joints, suspension, tie-rod ends, drive shaft and U-joints. Lubricate if equipped with grease fittings.

### Other maintenance items

Every 30000 miles (48000 km)	Replace engine air filter.
Every 60000 miles (96000 km)	Change automatic transmission fluid and filter. Consult dealer for requirements.
	Replace front wheel bearing grease and grease seal if non-sealed bearings are used.
Every 97,500 miles (157000 km)	Replace spark plugs.

## Scheduled Maintenance

---

<b>Other maintenance items</b>	
Every 105000 miles (168000 km)	Change engine coolant.*
	Replace rear axle fluid.
	Inspect accessory drive belt(s).**
Every 150000 miles (240000 km)	Replace accessory drive belt(s) if not replaced within the last 100000 miles (160000 km).
	Replace front wheel bearings and seals if non-sealed bearings are used.

\* Initial replacement at six years or 105000 miles (168000 kilometers), then every three years or 45000 miles (72000 kilometers).

\*\* If not replaced, inspect every 15000 miles (24000 kilometers).

# Scheduled Maintenance

## SPECIAL OPERATING CONDITIONS SCHEDULED MAINTENANCE

If you operate your vehicle **primarily** in any of the following conditions, you need to

perform extra maintenance as indicated. If you operate your vehicle **occasionally** under any of these conditions, it is not necessary to perform the extra maintenance. For specific recommendations, see your dealership service advisor or technician.

<b>Towing a trailer or using a car-top carrier</b>	
Inspect frequently, service as required	Inspect U-joints.
	See axle maintenance items under <b>Exceptions</b> .
Every 5000 miles (8000 km)	Inspect the wheels and related components for abnormal noise, wear, looseness or drag.
	Rotate tires*, inspect tires for wear and measure tread depth.
Every 5000 miles (8000 km) or six months	Change engine oil and filter.
	Inspect U-joints.
Every 30000 miles (48000 km)	Replace front wheel bearing grease and grease seals if non-sealed bearings are used.
Every 60000 miles (96000 km)	Replace spark plugs.

\*Vehicles equipped with dual rear wheels should rotate the front wheels when specified; rear wheels only if unusual wear is noted.

<b>Extensive idling or low-speed driving for long distances, as in heavy commercial use (such as delivery, taxi, patrol car or livery)</b>	
Every 5000 miles (8000 km)	Inspect brake system.
	Inspect wheels and related components for abnormal noise, wear, looseness or drag.
	Rotate tires*, inspect tires for wear and measure tread depth.
Every 5000 miles (8000 km) or six months	Inspect U-joints.

## Scheduled Maintenance

<b>Extensive idling or low-speed driving for long distances, as in heavy commercial use (such as delivery, taxi, patrol car or livery)</b>	
Every 5000 miles (8000 km) or six months or 200 engine hours	Change engine oil and filter.
Every 30000 miles (48000 km)	Replace front wheel bearing grease and grease seals if non-sealed bearings are used.
Every 60000 miles (96000 km)	Replace spark plugs.

\*Vehicles equipped with dual rear wheels should rotate the front wheels when specified; rear wheels only if unusual wear is noted.

<b>Operating in dusty or sandy conditions (such as unpaved or dusty roads)</b>	
Inspect frequently, service as required	Replace engine air filter.
	Replace cabin air filter, if equipped.
Every 5000 miles (8000 km)	Inspect the wheels and related components for abnormal noise, wear, looseness or drag.
	Rotate tires*, inspect tires for wear and measure tread depth.
Every 5000 miles (8000 km) or six months	Change engine oil and filter.
	Inspect U-joints.
Every 30000 miles (48000 km)	Replace front wheel bearing grease and grease seals if non-sealed bearings are used.
Every 50000 miles (80000 km)	Change rear axle fluid.

\*Vehicles equipped with dual rear wheels should rotate the front wheels when specified; rear wheels only if unusual wear is noted.

### Exceptions

There are several exceptions to the Normal Schedule:

# Scheduled Maintenance

Rear axle fluid change or level check not required unless leak is suspected or the assembly has been submerged in water. During long periods of trailer towing with outside temperatures above 70°F (21°C) and at wide-open throttle for long periods above 45 mph (72 km/h), change rear axle fluid every 24,000 mi (38,000 km) or three months, whichever comes first.

**California fuel filter replacement:** If you register your vehicle in California, the California Air Resources Board has determined that the failure to perform this maintenance item does not nullify the emission warranty or limit recall liability before the completion of your vehicle's useful life. Ford Motor Company, however, urges you to have all recommended maintenance services performed at the specified intervals and to record all vehicle service.

## Hot climate oil change intervals:

Vehicles operating in the Middle East, North Africa, Sub-Saharan Africa or locations with similar climates using an American Petroleum Institute (API) Certified for Gasoline Engines (Certification mark) oil of SM or SN quality, the normal oil change interval is 5000 miles (8000 kilometers).

If the available API SM or SN oils are not available, then the oil change interval is 3000 miles (4800 kilometers).

## Engine air filter and cabin air filter replacement:

The life of the engine air filter and cabin air filter is dependent on exposure to dusty and dirty conditions. Vehicles operated in these conditions require frequent inspection and replacement of the engine air filter and cabin air filter.

## SCHEDULED MAINTENANCE RECORD

<input type="radio"/> Repair Order #:	<p>Dealer stamp</p>
<input type="radio"/> Distance:	
<input type="radio"/> Engine hours (optional):	
<input type="radio"/> Multi-point inspection (recommended): <input type="checkbox"/>	
<input type="radio"/> Signature:	

# Scheduled Maintenance

<input type="radio"/> Repair Order #:	Dealer stamp
<input type="radio"/> Distance:	
<input type="radio"/> Engine hours (optional):	
<input type="radio"/> Multi-point inspection (recommended): <input type="checkbox"/>	
<input type="radio"/> Signature:	

<input type="radio"/> Repair Order #:	Dealer stamp
<input type="radio"/> Distance:	
<input type="radio"/> Engine hours (optional):	
<input type="radio"/> Multi-point inspection (recommended): <input type="checkbox"/>	
<input type="radio"/> Signature:	

# Scheduled Maintenance

<input type="radio"/> Repair Order #:	<p>Dealer stamp</p>
<input type="radio"/> Distance:	
<input type="radio"/> Engine hours (optional):	
<input type="radio"/> Multi-point inspection (recommended): <input type="checkbox"/>	
<input type="radio"/> Signature:	

<input type="radio"/> Repair Order #:	<p>Dealer stamp</p>
<input type="radio"/> Distance:	
<input type="radio"/> Engine hours (optional):	
<input type="radio"/> Multi-point inspection (recommended): <input type="checkbox"/>	
<input type="radio"/> Signature:	



# Scheduled Maintenance

<input type="radio"/> Repair Order #:	Dealer stamp
<input type="radio"/> Distance:	
<input type="radio"/> Engine hours (optional):	
<input type="radio"/> Multi-point inspection (recommended): <input type="checkbox"/>	
<input type="radio"/> Signature:	

<input type="radio"/> Repair Order #:	Dealer stamp
<input type="radio"/> Distance:	
<input type="radio"/> Engine hours (optional):	
<input type="radio"/> Multi-point inspection (recommended): <input type="checkbox"/>	
<input type="radio"/> Signature:	

# Scheduled Maintenance

<input type="radio"/> Repair Order #:	<p>Dealer stamp</p>
<input type="radio"/> Distance:	
<input type="radio"/> Engine hours (optional):	
<input type="radio"/> Multi-point inspection (recommended): <input type="checkbox"/>	
<input type="radio"/> Signature:	

<input type="radio"/> Repair Order #:	<p>Dealer stamp</p>
<input type="radio"/> Distance:	
<input type="radio"/> Engine hours (optional):	
<input type="radio"/> Multi-point inspection (recommended): <input type="checkbox"/>	
<input type="radio"/> Signature:	

# Scheduled Maintenance

<input type="radio"/> Repair Order #:	<p>Dealer stamp</p>
<input type="radio"/> Distance:	
<input type="radio"/> Engine hours (optional):	
<input type="radio"/> Multi-point inspection (recommended): <input type="checkbox"/>	
<input type="radio"/> Signature:	

<input type="radio"/> Repair Order #:	<p>Dealer stamp</p>
<input type="radio"/> Distance:	
<input type="radio"/> Engine hours (optional):	
<input type="radio"/> Multi-point inspection (recommended): <input type="checkbox"/>	
<input type="radio"/> Signature:	

# Scheduled Maintenance

<input type="radio"/> Repair Order #:	<p>Dealer stamp</p>
<input type="radio"/> Distance:	
<input type="radio"/> Engine hours (optional):	
<input type="radio"/> Multi-point inspection (recommended): <input type="checkbox"/>	
<input type="radio"/> Signature:	

<input type="radio"/> Repair Order #:	<p>Dealer stamp</p>
<input type="radio"/> Distance:	
<input type="radio"/> Engine hours (optional):	
<input type="radio"/> Multi-point inspection (recommended): <input type="checkbox"/>	
<input type="radio"/> Signature:	

# Scheduled Maintenance

<input type="radio"/> Repair Order #:	Dealer stamp
<input type="radio"/> Distance:	
<input type="radio"/> Engine hours (optional):	
<input type="radio"/> Multi-point inspection (recommended): <input type="checkbox"/>	
<input type="radio"/> Signature:	

<input type="radio"/> Repair Order #:	Dealer stamp
<input type="radio"/> Distance:	
<input type="radio"/> Engine hours (optional):	
<input type="radio"/> Multi-point inspection (recommended): <input type="checkbox"/>	
<input type="radio"/> Signature:	

# Scheduled Maintenance

<input type="radio"/> Repair Order #:	<p>Dealer stamp</p>
<input type="radio"/> Distance:	
<input type="radio"/> Engine hours (optional):	
<input type="radio"/> Multi-point inspection (recommended): <input type="checkbox"/>	
<input type="radio"/> Signature:	

<input type="radio"/> Repair Order #:	<p>Dealer stamp</p>
<input type="radio"/> Distance:	
<input type="radio"/> Engine hours (optional):	
<input type="radio"/> Multi-point inspection (recommended): <input type="checkbox"/>	
<input type="radio"/> Signature:	

# Scheduled Maintenance

<input type="radio"/> Repair Order #:	<p>Dealer stamp</p>
<input type="radio"/> Distance:	
<input type="radio"/> Engine hours (optional):	
<input type="radio"/> Multi-point inspection (recommended): <input type="checkbox"/>	
<input type="radio"/> Signature:	

<input type="radio"/> Repair Order #:	<p>Dealer stamp</p>
<input type="radio"/> Distance:	
<input type="radio"/> Engine hours (optional):	
<input type="radio"/> Multi-point inspection (recommended): <input type="checkbox"/>	
<input type="radio"/> Signature:	

# Scheduled Maintenance

---

<input type="radio"/> Repair Order #:	<p>Dealer stamp</p>
<input type="radio"/> Distance:	
<input type="radio"/> Engine hours (optional):	
<input type="radio"/> Multi-point inspection (recommended): <input type="checkbox"/>	
<input type="radio"/> Signature:	



# Appendices

## TYPE APPROVALS

### RF Certification Logos for Tire Pressure Monitoring Sensor(s)

Schrader AG2SZ4 Numero de Registro  
CNC: H-13498

E207816

Argentina

TRA  
REGISTERED NO:ER0130238/14  
DEALER NO:DA0047074/10

E207817

Abu Dhabi, Dubai

 MODELO: AG2SZ3  
2109-14-8001  
  
(01)07898953530292

E197509



E202555

Brazil

Herby, Schrader Electronics UK Ltd., declares that this TPMS is in compliance with the essential requirements and other provisions of directive 1999/5/EC. The declaration of conformity may be consulted at [emcteam@schrader.co.uk](mailto:emcteam@schrader.co.uk)

E207818

European Union EU

Kingdom of Jordan Type approval for tyre pressure sensor.  
Model: AG2SZ4  
Manufacturer: Schrader Electronics  
Type Approval Number: TRC/LPD/2014/56

E207819

Jordan

RAQP/33A/0514/S/(14-0847)

E207820

Malaysia

# Appendices



1 0 2 4

E197811

Moldova

AGREE PAR L'ANRT MAROC  
Numéro d'agrément: MR9098  
ANRT 2014  
Date d'agrément: 14/03/2014

E207821

Morocco



Type Approved

**NTC**

No:ESD-1408639C

E198001

Philippines

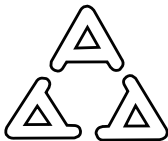

И 011 14

E197844

Serbia

Complies with  
IDA Standards  
DA 00461

E207822

Singapore



TA-2014/064

Approved

E198002

South Africa



**CCAM14LP0460T0**

E203899

# Appendices

---



CCAM14LP0090T3

E203679

Taiwan



Schrader Electronics цім стверджує, що обладнання Радіопередавач моделі AG2S24 системи контролю тиску в шині автомобіля відповідає вимогам Технічного регламенту радіоблагоднання і телекомунікаційного кінцевого (термінального) обладнання (Постанова КМУ № 679 від 24 червня 2009 р.) Декларація відповідності знаходиться на сайті Schrader

Electronics та надається за запитом на електронну адресу [doc.request@schrader.co.uk](mailto:doc.request@schrader.co.uk)

E198009

Ukraine

# Index

## A

About This Manual.....	5
ABS	
See: Brakes.....	40
ABS driving hints	
See: Hints on Driving With Anti-Lock Brakes.....	40
Accessories	
See: Replacement Parts	
Recommendation.....	8
Adjusting the Steering Wheel.....	12
Air Filter	
See: Changing the Engine Air Filter.....	103
Appendices.....	158
Audible Warnings and Indicators.....	20
Fail-Safe Cooling Warning Chime.....	20
Headlamps On Warning Chime.....	20
Key in Ignition Warning Chime.....	20
Parking Brake On Warning Chime.....	20
Shift to Park Warning Chime.....	20
Automatic Transmission.....	37
Brake-Shift Interlock.....	39
If Your Vehicle Gets Stuck In Mud or Snow.....	39
Understanding the Positions of Your Automatic Transmission.....	37
Automatic Transmission Fluid	
Check.....	97
Adjusting automatic transmission fluid levels.....	98
Automatic transmission fluid filter.....	99
Correct fluid level.....	98
High fluid level.....	98
Low fluid level.....	98

## B

Battery	
See: Changing the 12V Battery.....	101
Brake Fluid Check.....	99
Hydroboost.....	100
Hydromax.....	99
Brakes.....	40
General Information.....	40
Breaking-In.....	54

## C

California Proposition 65.....	7
Capacities and Specifications.....	133
Alternative Engine Oil for Extremely Cold Climates.....	136
Specifications.....	134
Car Wash	
See: Cleaning the Exterior.....	105
Catalytic Converter.....	34
On-Board Diagnostics (OBD-II).....	35
Readiness for Inspection and Maintenance (I/M) Testing.....	35
Changing a Fuse.....	87
Fuses.....	87
Changing a Road Wheel.....	125
Dissimilar Spare Wheel and Tire Assembly Information.....	125
Tire Change Procedure.....	126
Changing the 12V Battery.....	101
Battery relearn.....	102
Changing the Engine Air Filter.....	103
Cleaning the Engine.....	106
Cleaning the Exterior.....	105
Cleaning the Headlamps.....	105
Exterior Chrome Parts.....	105
Exterior Plastic Parts.....	105
Stripes or Graphics.....	105
Underbody.....	106
Under Hood.....	106
Cleaning the Wheels.....	106
Coolant Check	
See: Engine Coolant Check.....	93
Cruise Control.....	12
Principle of Operation.....	42
Cruise control	
See: Using Cruise Control.....	42
Customer Assistance.....	61

## D

Daytime Running Lamps.....	15
Direction Indicators.....	15
Driving Hints.....	54
Driving Through Water.....	55
DRL	
See: Daytime Running Lamps.....	15

# Index

## E

Economical Driving.....	54
Emission Law.....	33
Noise Emissions Warranty, Prohibited Tampering Acts and Maintenance.....	34
Tampering With a Noise Control System.....	33
Engine Block Heater.....	27
Using the Engine Block Heater.....	27
Engine Coolant Check.....	93
Adding Coolant.....	94
Coolant Change.....	95
Engine Coolant Temperature Management.....	96
Fail-Safe Cooling.....	95
Recycled Coolant.....	95
Severe Climates.....	95
Engine Emission Control.....	33
Engine Oil Check.....	91
Adding Engine Oil.....	92
Engine Oil Dipstick.....	91
Engine Specifications.....	129
Drivebelt Routing.....	129
Environment.....	11
Essential Towing Checks.....	51
Before Towing a Trailer.....	52
Hitches.....	51
Launching or Retrieving a Boat or Personal Watercraft (PWC).....	53
Safety Chains.....	51
Trailer Brakes.....	52
Trailer Lamps.....	52
When Towing a Trailer.....	52
Export Unique Options.....	10

## F

Ford Credit.....	8
US Only.....	8
Ford Protect.....	138
Ford Protect Extended Service Plan (CANADA ONLY).....	139
Ford Protect Extended Service Plans (U.S. Only).....	138
Fuel and Refueling.....	28
Fuel Consumption.....	31
Calculating Fuel Economy.....	31

Filling the Fuel Tank.....	31
Fuel Filter.....	101
Fuel Quality.....	28
Choosing the Right Fuel.....	28
Fuses.....	68
Fuse Specification Chart.....	68
Diode and Relay Module.....	79
F53 Passenger Compartment Fuse Panel.....	81
F53 Power Distribution Box.....	68

## G

Gauges.....	16
Engine Coolant Temperature Gauge.....	17
Engine Oil Pressure Gauge.....	16
Fuel Gauge.....	17
Speedometer.....	16
Transmission Fluid Temperature Gauge.....	17
Gearbox See: Transmission.....	37
General Maintenance Information.....	140
Multi-point Inspection.....	142
Owner Checks and Services.....	141
Protecting Your Investment.....	140
Why Maintain Your Vehicle?.....	140
Why Maintain Your Vehicle at Your Dealership?.....	140
Getting Assistance Outside the U.S. and Canada.....	64
Getting the Services You Need.....	61
Away From Home.....	61

## H

Handbrake See: Parking Brake.....	41
Hazard Flashers.....	57
Hints on Driving With Anti-Lock Brakes.....	40

## I

Ignition Switch.....	25
In California (U.S. Only).....	62
Information Displays.....	21
General Information.....	21

# Index

Information Messages.....	22
Engine.....	23
Maintenance.....	23
Transmission.....	24
Instrument Cluster.....	16
Instrument Lighting Dimmer.....	14
Introduction.....	5

## J

Jump Starting the Vehicle.....	57
Connecting the Jumper Cables.....	58
Jump Starting.....	59
Preparing Your Vehicle.....	58
Removing the Jumper Cables.....	59

## L

Lighting Control.....	14
Headlamp Flasher.....	14
High Beams.....	14
Lighting.....	14
Load Carrying.....	43
Load Limit.....	43
Special Loading Instructions for Owners of Pick-up Trucks and Utility-type Vehicles.....	47
Vehicle Loading - with and without a Trailer.....	43
Lug Nuts	
See: Changing a Road Wheel.....	125

## M

Maintenance.....	89
General Information.....	89
Message Center	
See: Information Displays.....	21
Mobile Communications Equipment.....	9
Motorcraft Parts.....	129

## N

Normal Scheduled Maintenance.....	143
-----------------------------------	-----

## O

Oil Change Indicator Reset.....	93
Resetting the Oil Life Monitoring System.....	93
Oil Check	
See: Engine Oil Check.....	91
Ordering Additional Owner's Literature.....	65
Obtaining a French Owner's Manual.....	66

## P

Parking Brake.....	41
Perchlorate.....	7
Power Steering Fluid Check.....	100
Steering linkage lubrication points.....	101
Protecting the Environment.....	11

## R

Recommended Towing Weights.....	49
Reduced Engine Performance.....	54
Refueling.....	29
Replacement Parts	
Recommendation.....	8
Collision Repairs.....	8
Scheduled Maintenance and Mechanical Repairs.....	8
Warranty on Replacement Parts.....	8
Reporting Safety Defects (Canada Only).....	66
Reporting Safety Defects (U.S. Only).....	66
Roadside Assistance.....	56
Vehicles Sold in Canada: Getting Roadside Assistance.....	57
Vehicles Sold in Canada: Roadside Assistance Program Coverage.....	57
Vehicles Sold in Canada: Using Roadside Assistance.....	57
Vehicles Sold in the United States: Getting Roadside Assistance.....	56
Vehicles Sold in the United States: Using Roadside Assistance.....	56
Roadside Emergencies.....	56
Running-In	
See: Breaking-In.....	54

# Index

Running Out of Fuel.....29

## S

Safety Precautions.....28

Scheduled Maintenance Record.....147

Scheduled Maintenance.....140

Snow Chains

See: Using Snow Chains.....124

Spare Wheel

See: Changing a Road Wheel.....125

Special Notices.....8

New Vehicle Limited Warranty.....8

On Board Diagnostics Data Link

Connector.....9

Special Instructions.....9

Special Operating Conditions Scheduled Maintenance.....145

Exceptions.....146

Speed Control

See: Cruise Control.....42

Starter Switch

See: Ignition Switch.....25

Starting a Gasoline Engine.....25

Failure to Start.....26

Guarding Against Exhaust Fumes.....26

Important Ventilating Information.....26

Stopping the Engine When Your Vehicle is

Moving.....26

Stopping the Engine When Your Vehicle is

Stationary.....26

Starting and Stopping the Engine.....25

General Information.....25

Steering Wheel.....12

Symbols Glossary.....5

## T

Technical Specifications

See: Capacities and Specifications.....129

The Better Business Bureau (BBB) Auto Line Program (U.S. Only).....63

Tire Care.....109

Glossary of Tire Terminology.....110

Information About Uniform Tire Quality

Grading.....109

Information Contained on the Tire

Sidewall.....111

Temperature A B C.....110

Traction AA A B C.....109

Treadwear.....109

Tires

See: Wheels and Tires.....109

Towing a Trailer.....48

Load Placement.....48

Towing the Vehicle on Four Wheels.....53

Emergency Towing.....53

Towing.....48

Transmission Code Designation.....132

Transmission.....37

Transporting the Vehicle.....59

Type Approvals.....158

RF Certification Logos for Tire Pressure

Monitoring Sensor(s).....158

## U

Under Hood Overview - Commercial

Chassis.....89

Under Hood Overview - Motorhome

Chassis.....90

Using Cruise Control.....42

Switching Cruise Control Off.....42

Switching Cruise Control On.....42

Using Snow Chains.....124

Utilizing the Mediation/Arbitration

Program (Canada Only).....64

## V

Vehicle Care.....105

General Information.....105

Vehicle Certification Label.....132

Vehicle Identification Number.....131

Vehicle Storage.....106

Battery.....107

Body.....107

Brakes.....107

Cooling system.....107

Engine.....107

Fuel system.....107

General.....107

Miscellaneous.....108

Removing Vehicle From Storage.....108

Tires.....107

# Index

---

VIN

See: Vehicle Identification Number.....131

## W

Warning Lamps and Indicators.....18

Anti-Lock Brake System Warning

Lamp.....18

Battery.....18

Brake Reserve System.....19

Brake System Warning Lamp.....18

Cruise Control Indicator.....19

Direction Indicator.....19

Electronic Throttle Control.....19

Fasten Seatbelt Warning Lamp.....19

Headlamp High Beam Indicator.....19

Service Engine Soon.....19

Tow Haul Indicator.....20

Washers

See: Cleaning the Exterior.....105

See: Wipers and Washers.....13

Wheel Nuts

See: Changing a Road Wheel.....125

Wheels and Tires.....109

Technical Specifications.....128

Windshield Washers.....13

Windshield Wipers.....13

Wipers and Washers.....13