



DIRECTV USER GUIDE

HD AND SD STANDARD RECEIVERS



This DIRECTV Set Top Box meets
ENERGY STAR guidelines.*

*May not apply to
older models.

Welcome to the DIRECTV Standard or HD receiver. Now that you're plugged in, it's time to start enjoying your access to over 265 channels of TV programming, including Sirius XM satellite music channels, plus an extensive Pay Per View selection. This User Guide will take you step by step through everything from pushing the POWER button to searching and finding your favorite programs.

If you're new to DIRECTV or just want to know the essentials, simply read the Chapter 1 Quick Start. If you want to become an expert, read Chapter 2 to get all the details.

This user guide applies to Standard Definition (SD), as well as High Definition (HD) receivers. Sections devoted exclusively to HD are marked with the HD ONLY icon  and placed on a light blue background.

Getting Connected

If a professional installed your DIRECTV® Receiver, you are ready to start watching TV.

If your receiver was not professionally installed or you just added a surround sound system or other equipment, please see Chapter 3: Installation and Connections.

IMPORTANT:

- You must subscribe to the HD Access fee in order to be able to view the HD channels included in your programming package.
- DIRECTV hardware, programming, and HD Access fee available separately.

For information and pricing regarding programming, and HD Access fee, please visit directv.com.

TABLE OF CONTENTS

- Welcome to the DIRECTV Family3
- Safety & Care8

CHAPTER 1: QUICK START

- **Using Your Remote Control.....12**
 - Turning Equipment On and Off12
 - Navigation and Destination Buttons13
 - Short Cut Buttons13
- **Viewing Live Television.....14**
 - Program Guide14
 - Local Channels14
 - HD & SD Channels15
 - Unsubscribed Channels15
 - Guide Banners16
 - Mini Guide16
 - Channel Banner17
 - Interactive Channels18
 - Pay Per View20
 - Main Menu21

CHAPTER 2: DETAILED INFORMATION

- **Program Guide Features and Options24**
 - Filtering the Guide24
 - Guide Options25
 - Special Feature: Channel Program List27
- **Live TV Features and Options28**
 - Live TV Options28
- **Main Menu - Overview30**
- **Main Menu - Search for Shows31**
 - Search by Title31
 - Search by Person32
 - Search by Channel33
 - Search by Keyword34
 - Recent Searches35
- **Main Menu - Manage Autotunes36**
 - To Do List36
 - History37
 - Purchases37
 - Manual Autotunes37

- **Main Menu - Caller ID & Messages38**
 - Messages38
 - Caller ID39
- **Main Menu - Customer Care & Help40**
 - Help Topics and FAQs40
- **Main Menu - Parental, Fav's & Settings41**
 - Parental Controls41
 - Favorite Channels47
 - System Setup48
 - Reset56

CHAPTER 3: INSTALLATION AND CONNECTIONS

- **Installation.....58**
 - Your Phone Connection58
 - Connections for Auxiliary Equipment.....58
 - Guided Setup62
 - Activate Your DIRECTV® Service62
 - Programming Your Remote Control63

CHAPTER 4: TROUBLESHOOTING TIPS

- **Troubleshooting Tips66**
 - Resetting/Reauthorizing Your Receiver66
 - System Software Updates67
 - On-Screen Error Messages67
- **DIRECTV® Receiver or TV Problems 68**
- **Remote Control Problems 75**
- **Running the System Test 76**

TABLE OF CONTENTS

CHAPTER 5: WARRANTY & OTHER INFORMATION

- Limited 90-Day Warranty78
- Product Information81
- DIRECTV Protection Plan82
- FCC Customer Information84
- Terms & Conditions for Use of Software88

APPENDICES

- 1. SD and HD Receivers Front and Back Panels92
 - Standard Receiver92
 - HD Receiver 96
- 2. About High Definition100
- Index 107

Your DIRECTV® Receiver has been designed and manufactured to stringent quality and safety standards. You should, however, be aware of the following important precautions for safe and optimal use of the equipment.

Meaning of symbols printed on the rear panel of the product:



This symbol indicates that dangerous voltage consisting a risk of electric shock is present within this unit.



This symbol indicates that there are important operating and maintenance instructions in the literature accompanying this unit.

Important Safety Instructions

- 1) Read these instructions.
- 2) Keep these instructions.
- 3) Heed all warnings.
- 4) Follow all instructions.
- 5) Do not use this apparatus near water.
- 6) Clean only with dry cloth.
- 7) Do not block any ventilation openings. Install in accordance with the manufacturer's instructions.
- 8) Do not install near any heat sources such as radiators, heat registers, stoves, or other apparatus (including amplifiers) that produce heat.
- 9) Do not defeat the safety purpose of the polarized or grounding-type plug. A polarized plug has two blades with one wider than the other. A grounding type plug has two blades and a third grounding prong. The wide blade or the third prong are provided for your safety. If the provided plug does not fit into your outlet, consult an electrician for replacement of the obsolete outlet.
- 10) Protect the power cord from being walked on or pinched particularly at plugs, convenience receptacles, and the point where they exit from the apparatus.
- 11) Only use attachments/accessories specified by the manufacturer.
- 12) Use only with the cart, stand, tripod, bracket, or table specified by the manufacturer, or sold with the apparatus. When a cart is used, use caution when moving the cart/apparatus combination to avoid injury from tip-over.
- 13) Unplug this apparatus during lightning storms or when unused for long periods of time.
- 14) Refer all servicing to qualified service personnel. Servicing is required when the apparatus has been damaged in any way, such as power-supply cord or plug is damaged, liquid has been spilled or objects have fallen into the apparatus, the apparatus has been exposed to rain or moisture, does not operate normally, or has been dropped.



WARNING: To reduce the risk of fire or electric shock, do not expose this product to rain or moisture. The apparatus shall not be exposed to dripping or splashing and no objects filled with liquids, such as vases, shall be placed on the apparatus.

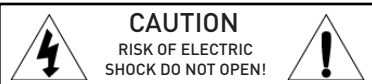

CAUTION: To reduce the risk of electric shock, do not remove cover (or back). No user-serviceable parts inside. Refer servicing to qualified service personnel.

IMPORTANT: Be sure not to place your DIRECTV® Receiver near anything WET or HOT! If this product is used at 240VAC, a suitable attachment plug should be used.

CAUTION: Avoid moisture to reduce the risk of fire or electric shock. The DIRECTV® Receiver should not be used near water (for example, kitchen sink, bathtub, pool, damp basement). Also, never spill liquid on the receiver, and do not place vases or other vessels containing liquid on top of it.

TIP: We highly recommend plugging the DIRECTV® Receiver into a surge protector to prevent damage from fluctuations in your power supply.

- Ensure proper ventilation — the vent slots on the DIRECTV® Receiver must be left uncovered to allow proper airflow to the unit. Blocking the airflow to the unit could impair performance or damage your receiver and other components.
- Do not stack electronic components or other objects on top of the DIRECTV® Receiver. Also, do not stack the receiver on top of a "hot component" such as an audio power amplifier.
- Protect your components from power surges by connecting all the components before plugging any power cords into the wall outlet. Use of a surge protector is also recommended.
- Don't overload power outlets or extension cords, which can result in the risk of fire or shock. It's also important to use only the type of power source indicated on the marking label or in this manual.
- Avoid audio hum or interference by inserting all cable plugs firmly into their jacks. Also, place Audio/Video (A/V) cables to the sides of the TV back panel rather than down the middle once connected. Try not to coil any twin-lead cables and keep them away from A/V cables as much as possible.
- Never insert objects of any kind into any openings in the DIRECTV® Receiver (other than the DIRECTV® Access Card as detailed in this manual).
- Place it on a flat, hard surface — do not operate the DIRECTV® Receiver on a carpet or other padded surface.
- Always unplug your DIRECTV® Receiver before moving it.
- Always unplug the DIRECTV® Receiver, TV and other equipment before you connect or disconnect any cables.
- The only way to disconnect the DIRECTV® Receiver from the power supply is to remove the power cord. The DIRECTV® Receiver unit must therefore be installed next to the power point which must be easily accessible.
- **CAUTION: Electric Shock** — never attempt to disassemble the DIRECTV® Receiver yourself; always take it to a qualified service person when repair is required. Opening or removing covers may expose dangerous voltage or other risks, and incorrect reassembly can cause shock when receiver is subsequently used. Attempted self-repair may also void your warranty. Changes or modifications not expressly approved by the party responsible for compliance (by the warranty or by the manufacturer) could void the user's authority to operate the equipment.
- Do not drop your DIRECTV® Receiver and always move it with care.
- Have your DIRECTV® Receiver professionally serviced (do not attempt to service it yourself).
- Any changes or modifications in construction of this device which are not expressly approved by the party responsible for compliance could void the user's authority to operate the equipment.
- If you move your DIRECTV® Receiver between locations at different temperatures, allow it to reach room temperature before you apply power to it.
- Do not pick up or otherwise move your DIRECTV® Receiver while it is connected to the AC power supply. If you want to move your set-top box, first disconnect it, then wait at least 30 seconds before continuing
- To reduce the risk of fire, use only No. 26 AWG or better telecommunications line cord.

For your information: The identification sticker can be located underneath or on the back of your receiver. The telecommunication network voltage used is the category number 3.

Note to Satellite Dish Installer

This reminder is provided to call your attention to articles 810 and 820 of the 2005 National Electrical Code. Refer to article 810, in particular 810-1 and 810-15, for required grounding of the metal structure of the dish antenna. Refer also to the 810-2 which, by reference to article 820, requires that the satellite dish coaxial cable shield be connected to the grounding system of the building as close to the point of cable entry as practical.

CHAPTER 1 - QUICK START

- USING YOUR REMOTE CONTROL12
- VIEWING LIVE TELEVISION14

This universal remote control is your touch point to the system, so we'll start there.

Turning Equipment On and Off



Note:

Each time you press a button, a green light at the top of the remote flashes. If the light flashes several times for just one press, it means the batteries (size AA) are getting low and need to be replaced.

These two buttons turn your TV and DIRECTV® Receiver on or off together. If your DIRECTV® System was installed professionally, your remote has already been programmed to operate your TV. If you need to reprogram the remote for a new TV or for any other reason, press MENU, choose Parental, Fav's & Settings, then System Setup, then Remote, then Program Remote and follow the step by step instructions.

Mode Switch

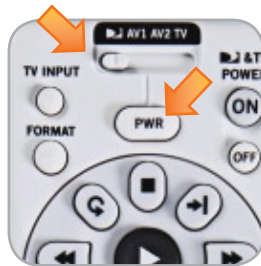

Use the POWER (PWR) button and Mode Switch to turn a single component on or off (for example a DVD player or surround sound system). Simply slide the mode switch to the position that matches the component you want to control and then use the POWER button to turn it off or on. The mode switch must always be in the left-most position to control your DIRECTV® Receiver. If the mode switch is in a position that has not been programmed, or if you press a button that is not supported by that particular piece of equipment, an on-screen message will pop up to alert you.

Navigation and Destination Buttons



You already know how to use the buttons on the bottom half of the remote. The digit keys, volume, etc. work the same way they do on any other remote. These buttons in the middle of the remote are navigation and destination keys.

Press the **GUIDE** button to go to the program guide screen. Press the **ACTIVE** button to go to the **DIRECTV Interactive services home page**. The **LIST** button takes you to the **To Do List**. See Chapter 2, “Manage Autotunes” for details. Press **EXIT** to get out of any menu screen and return to live TV. Use the **ARROW** buttons and **SELECT** button to navigate through the guide or any menu screen. Press **BACK** to move back to the previous screen. (You can also use the **LEFT ARROW** button to step backward one column at a time.) The **MENU** key takes you to the **main menu** where you go to access all of the features available in your system. Press **INFO** on any show to see information about that show.

Short Cut Buttons



You can move through all of the DIRECTV user screens using only the direction **ARROW** buttons and the **SELECT** button as appropriate. However, the **RED, GREEN, YELLOW, and BLUE** buttons on the remote are special short cuts that change function depending on which menu screen you are looking at. As you use the system look in the **bottom right** of particular screens for hints that tell you which color button to use for a particular short cut. You’ll see several examples in this chapter.



Shortcut hints



Program Guide

To see what's showing, press the **GUIDE** button to bring up the on-screen program guide. The guide holds 7 days (3 days for SD) of programming information for you.

The current programs are listed on the left side of the guide. The future programs are off to the right. Move the yellow highlight onto the current program you want to watch and press **SELECT** to tune to it.

You can navigate in the guide three ways: use the **ARROW** buttons to move one cell at a time up/down/left/right; use the **CHAN/PAGE** button to scroll a whole page up or down; type in the channel number to go directly there. Look for the color-button hints at the bottom of the screen for short cuts (i.e. use the **GREEN** button to move ahead in time 12 hours, once there use the red key to come back 12 hours). If you press **GUIDE** twice, you'll see a screen that lets you filter the guide. See Chapter 2 "Program Guide Features and Options", "Filtering the Guide" for details.



Program Info

Channels

Programs

Local Channels

Your DIRECTV-provided local channels can be found in the guide from channel numbers 2 through 69.

If you have HD, depending on your local market, you may see an HD or SD version of a local channel.



HD and SD Channels



DIRECTV has a tremendous offering of HD channels and they are spread throughout the guide. To find them, look for HD after the channel call sign (i.e. STZHD or CNNHD) in the channel column of the guide and also look for HD after the program title in the guide. If you want to see only the HD version of a channel in the guide go to chapter 2, section Parental, Fav's & Settings/Settings/Display for instructions on how to make that setting.

Unsubscribed Channels

Channels in the guide that are not part of your subscription package are shown grayed out. You can customize your guide to hide those channels. See Chapter 2 "Program Guide Features and Options", "Customizing the Guide" for details.

DIRECTV **The Secret of My Father** guide

Thu 12:01p 11:00p - 12:30p PG-13

Movie, Comedy (2006) John Smith, Millie Hillis. A young girl discovers the special power her father has.
Secondary Audio, (AC, AL).

Thu 1/31	12:00p	12:30p	1:00p
500 DTV	Watch Pay Per View Previous Here!		
501 HB0DH	The Silver Boy HD		
501 HBO	The Silver Boy	The Final C... HD	
502 HBO2	Conversation with Miss Smith	The Final Chance...	
503 HBOS	The Secret of M...	Command Zero	
504 HBOW	Sierra Quest		

-12 hrs +12 hrs Guide Options

DIRECTV **Quiet Time** guide

Wed 7:14p 7:00p - 7:30p TV-PG

Movie (Drama), 2002, Joe Macauley, Danielle Lyful. Young woman sets out to find the man of her dreams.

Wed 12/15	7:00p	7:30p	8:00p
900 DEF	Quiet Time		Red Slippers
901 GHI	The Black Cat		
902 JKL	Local News	More News	
991 UVW	Helicopter Cops		
199 XYZ	Sierra Quest		
2 LAZ	My Red Bag		Up Too Late

All Channels -12 hrs +12 hrs Guide Options

Unsubscribed Channels

Chapter 1

Chapter 2

Chapter 3

Chapter 4

Chapter 5

Guide Banners

In the guide you will also notice from time to time a special row sandwiched between channels.

We use these “banners” to post important messages, or helpful hints, or to alert you to new products or services. If you are interested, simply press SELECT on the banner and it will take you to that destination.



Mini-guide

Once you are watching your show, if you want a quick look at what's on next, press the **BLUE** button to bring up a one-line mini program guide. You can use it for the current channel or you can type in a new channel number to see what's on there. Press SELECT on the new show if you want to go to that channel.

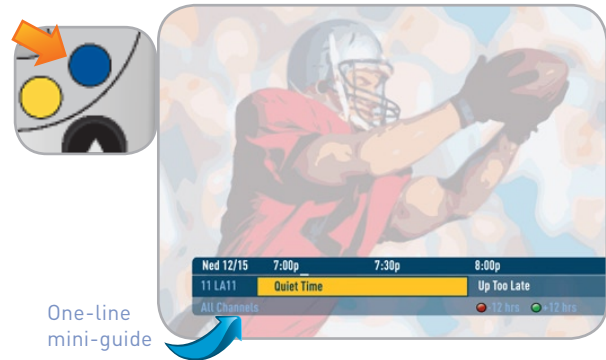

One-line mini-guide

Channel Banner

Once you see a current show in the guide that you want to watch, press SELECT and the receiver will tune to that channel. Then you will see a brief channel banner showing you the program name, channel number, date, time and other information. **You can bring up the channel banner at any time by pressing the INFO button.** The icons near the upper right give you more information about your show or your system such as whether a second audio language is available or if you have a system message waiting. Go to the inside of the back cover of this manual to get an explanation of all the icons. **If your program has an alternate audio track, press the GREEN button to hear it.** Press the YELLOW button to bring up the Live TV Options menu. You can turn closed captioning on, in addition to other actions. See Chapter 2 for details.



Interactive Channels

The DIRECTV ACTIVE® channel is the home of DIRECTV Interactive Service. Press the ACTIVE button on your remote to get the latest weather, horoscopes, lottery results and more.

Interactive channels are unique because in addition to video and audio, they also contain a software application that lets you interact with what you see on the screen. When accessing these channels you will have to wait a few seconds for the software to download. The channel is ready to interact when the yellow highlight box appears.

When you want to exit an interactive channel, simply press GUIDE and pick the channel you want to move to or you can type in the new channel number while in the interactive channel.

Take a look at the program guide from channel 100 to 115 to find some of the other Interactive channels. The News Mix and Sports Mix channels let you see up to 8 of the hottest channels on one screen. Move the yellow highlight box around using the direction arrows on your remote to hear the audio associated with each channel. If you want to see one of the channels in full-screen mode, simply move the yellow highlight box on top of it and press SELECT.



- The Game Lounge™ service contains memory and skill games that you can play on-screen using only your remote. There are free as well as subscription-only games to play. If you are good enough, you will see your name on the leader board.
- Interactive content like scores, statistics and other information are also provided along with some of our special sports and entertainment channels. Look for an on-screen popup that lets you know when interactive content is available and follow the on-screen instructions to use the interactive features.

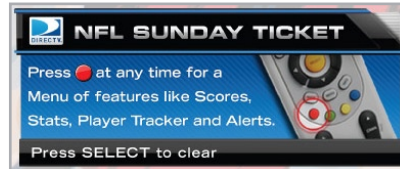

Pay Per View

You don't have to go out for the best and biggest movies and special events! Recent hits and events like sports, comedy and more are available 24 hours a day on DIRECTV Pay Per View. You'll find them listed in the program guide starting around channel 120.

To buy a program, tune to it directly or press INFO on the highlighted program in the Guide. Select the Buy option and follow the on-screen instructions. As long as your receiver is connected to a land-based phone line, you can use your remote to order.

You can cancel your Pay Per View order for any reason as long as none of the program has been viewed. If the program is set to autotune in the future, press MENU, then select Manage Autotunes, then To Do List. Highlight the program and press the RED button to delete it.

Note:

You can also order your DIRECTV Pay Per View movies and events on the Internet at directv.com or over the phone at 1-800-531-5000. Keep in mind, though, there is an additional ordering fee for purchases placed over the phone.

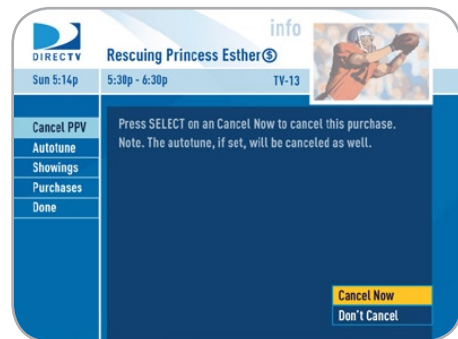

Main Menu

You don't really need it to surf through live TV, but the main menu can take you anywhere in the system, except to the guide.
Press **MENU** once to see the Main Menu . Press **MENU** again (or **EXIT**) to make it go away.

Note:

The SD receiver does not have the "Customer Care & Help" menu item.

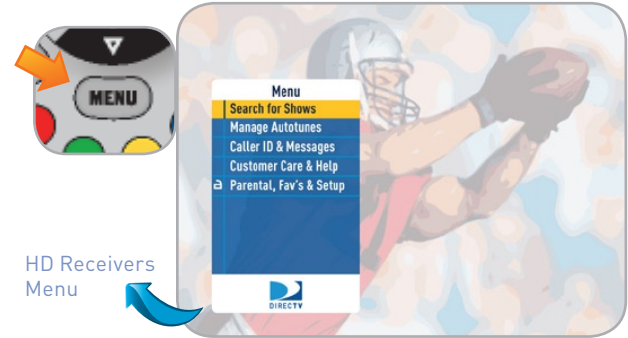

CHAPTER 2 - DETAILED INFORMATION

● PROGRAM GUIDE FEATURES AND OPTIONS	24
● LIVE TV FEATURES AND OPTIONS	28
● MAIN MENU	
● OVERVIEW	30
● SEARCH FOR SHOWS	31
● MANAGE AUTOTUNES	36
● CALLER ID & MESSAGES	38
● CUSTOMER CARE & HELP	40
● PARENTAL, FAV'S & SETTINGS	41

Filtering the Guide

In Chapter 1 you were told to press GUIDE once on the remote to bring up the program guide. That's great if you know where you want to go or are just browsing the huge selection of DIRECTV channels. However, there may be times when you want to temporarily trim down the channels that are shown in the guide, filtering them according to the type of program you are looking for. For example, you may want to see what's on for Sports or Movies or News. In that case, **press GUIDE twice to bring up the guide filter.**



You can also choose "HDTV Channels" to filter the guide to show only HD channels.

Simply use the arrow keys to get to the filter you want, press SELECT, and the guide will then show only that type of channel. **Look for the label in the bottom left of the guide to see how it is being filtered.** Since the filtering is temporary, it only lasts as long as you keep the program guide up on the screen. The next time you come into the guide, it will not be filtered and will again show all channels.



Look here to see how the guide is being filtered.

Guide Options

From the program guide screen, press the YELLOW button to bring up "Guide Options".

Sort Programs by Category

Select "Sort Programs by Category", then select a category to see a list of shows in chronological order that match your sort criterion.

Jump to a Date & Time

Select "Jump to a Date & Time" to quickly go to a future date and time in the Guide.

Pay Per View

Select Pay Per View and then the type of show you want to see a complete listing of what is available in the guide in chronological order.

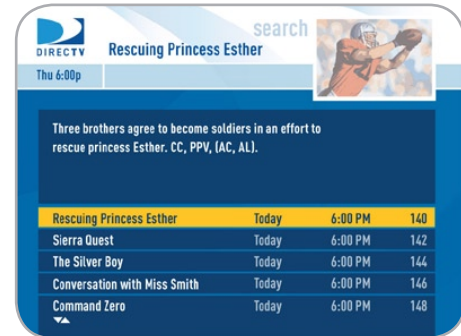
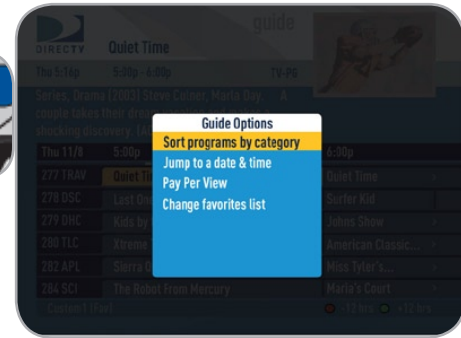

Change Favorites List (Customizing the Guide)

You can use “Change Favorites List” to create a completely custom list of channels selecting each individual channel that you want to see in your program guide.

Press **GUIDE**, use the color button hint at the bottom of the screen and press the **YELLOW** button to bring up the guide options menu. Select “Change Favorites List” and Edit Settings . Simply follow step by step screen instructions to create and name your custom channel list. The bottom left corner of the program guide screen shows your custom channel list name to tell you how the Guide is customized.



HD receivers have an option in “Change Favorites List” to display “Channels I Get” which will only show the channels to which you subscribe.

Special feature: Channel Program List

You can see all of the programs that are coming on a particular channel listed in chronological order. Press **GUIDE**, then move the highlight to the channel of interest and press **INFO**.

Highlight the channel

DIRECTV DTV PPV 127 guide

Wed 7:14p 7:00p - 7:30p TV-PG

DIRECTV Pay Per View Movie channel 127.

Wed 12/15	7:00p	7:30p	8:00p
127 PPV3	Quiet Time		
128 PPV4	Red Slippers		
129 PPV5	Red Slippers		
130 PPV6	Sierra Quest	Sierra Quest	
229 HGTV	Build your Ho...	Build your Ho...	Build your Ho...
236 E!	Beach City Fun		Up Too Late

All Channels -12 hrs +12 hrs Guide Options

The receiver will then sort through the guide and give you two weeks of programs in chronological order for that channel. Use the **ARROW** buttons to navigate up or down the list or use the **CHAN UP/DOWN** button to page through the list. Highlight a show in the list and press **INFO** to get more information about it. You can return to the guide by selecting **Done** or pressing **GUIDE** or using the **LEFT ARROW** button.

DIRECTV Football search

Thu 12:00p

Tune Now Done

News (Sports) 2008. The week in Football.

Programs: 631 FTB

Football	Today	12:00p	631
Sports News	Today	12:30p	631
Racing	Today	1:00p	631
Cycling	Today	2:00p	631
Tennis	Today	3:00p	631

+1.5hrs -1.5hrs

Live TV Options

While watching Live TV you can press the **YELLOW** button to bring up a list of options: View Previous Channels, Closed Captioning, Change Favorites List, Audio Options.

View Previous Channels

Press SELECT on “View previous channels” to see a short list of the channels you have watched previously. If you select a channel from this list the receiver will tune to that channel. This is an easy way to toggle between the channels you watch most often.

Closed Captioning

Press SELECT on Closed Captioning to toggle it ON or OFF.

Change Favorites List

Press SELECT on Change Favorites List to pick which list of channels shows up in your program guide. You can choose All Channels (some may not be in your programming package, so although you may see them in the guide you will not be able to tune to them), or any of your self-created lists.



If you have an HD receiver, you may also choose “Channels I Get” to see only the channels that are in your DIRECTV programming package.

You can also choose Edit Settings if you want to create a new list. See the Parental, Fav’s & Settings section near the end of this chapter for details.

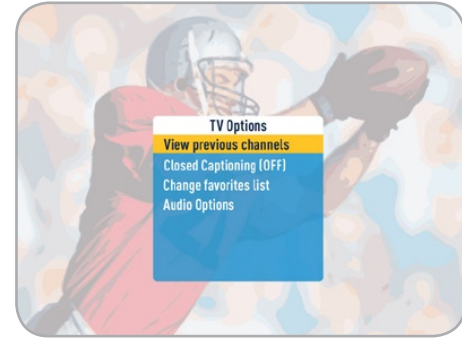

Look here to see to see if the guide is using a favorites list.

Audio Options

If the program you are watching is being broadcast with additional language audio tracks (such as Spanish), the “speaker” icon at the top-right is darkened. Select **Audio Options** and select the alternate language track you want (not all shows have an alternate language track) or press the **GREEN** button to cycle through the available audio tracks.



Press MENU on the remote to bring up the main menu. It lists important destinations in your DIRECTV® System. They are summarized below and explained in more detail in the remainder of this chapter.

Search for Shows

Finds shows by title, actor, or keyword that appear within the 7-day (3-day for SD) program guide. You can also search for channels here instead of browsing the entire Guide.

Manage Autotunes

Lets you see the status of shows (past and future) that the receiver is set to tune to automatically (Autotunes). You can also see past Pay Per View purchases listed and set an Autotune by channel and time.

Caller ID & Messages

Contains a log of the phone calls into your home (assuming you have a land line and Caller ID phone service) as well as DIRECTV® System messages to you.



Customer Care & Help

Provides access to a help glossary.

Parental, Fav's & Settings

Lets you set Parental Control limits, choose Favorite Channels for a customized program guide, and choose settings for your TV, remote, and your entire DIRECTV® System.

Use the search engine to find programs based on Title, Person, Channel or Keyword. This powerful tool finds all programs that match your criterion within the 7-day (3-day for SD) program guide.

Here's how it works:

Always start search by pressing MENU on the remote. Select Search for Shows and then select one of the following categories:

Search by Title

When you know the title you are searching for, enter it one letter at a time in the on-screen letter pad by highlighting the letter you want and pressing SELECT. (Note that you can choose Delete [DEL] to get rid of the last letter or Clear (CLR) to start over if you make a mistake.) You do not have to enter the initial article like "The" or "An". **Each time you enter a letter, the search becomes more precise.** You don't always have to enter the complete title. Just the first few letters will usually get you close enough. Then you can move the highlight to the list on the right and scroll or page down until you see your title.

Because your title can appear on several channels, it may have a folder icon next to it.



If it is in HD, it will have the HD icon next to it.

Press SELECT on the show to bring up the information screen.

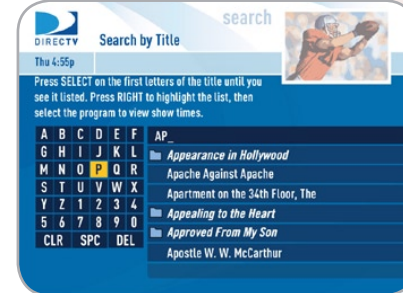

Search by Person

Use the letter pad to enter the first few letters of the person's last name. You will see a list on the right side of the screen showing you actors, actresses, and directors.

Select the name that you want and a list of show titles will appear.

If your person's name does not appear in the list, you might want to try the name in a Keyword search (see page 34).

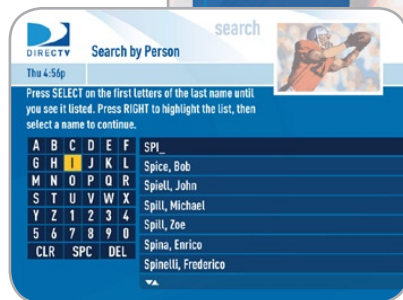
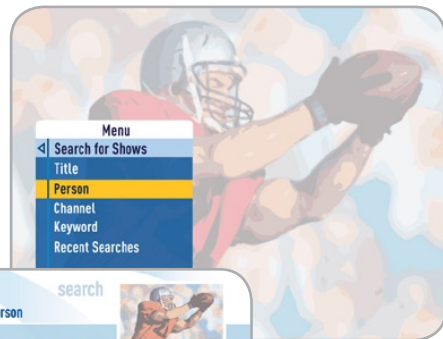

Search by Channel

You can also type in the channel name to find it instead of surfing through the large DIRECTV program guide.

Use the keypad to enter in the first few letters of the channel name. In this case we typed in "BL" to find Bloomberg.

If you select your desired channel from the list on the right you will get a list of the shows scheduled on that channel.

Menu

- Search for Shows
- Title
- Person
- Channel**
- Keyword
- Recent Searches

Search by Channel

Mon 11:19p

Press SELECT on the first letters of the channel name until you see it listed. Press RIGHT to highlight the list, then select the channel to view programs.

A	B	C	D	E	F	BL	
G	H	I	J	K	L	Bloomberg	353 BTV
M	N	O	P	Q	R	Boomerang	297 BOOM
S	T	U	V	W	X	Bravo	273 BRVO
Y	Z	1	2	3	4	BYU TV	374 BYU
5	6	7	8	9	0	Cable Response TV	243 CRTV
CLR	SPC	DEL				Cable Response TV INFO #2	268 IRTV

Search by Channel

Mon 11:19p

Press SELECT on the first letters of the channel name until you see it listed. Press RIGHT to highlight the list, then select the channel to view programs.

A	B	C	D	E	F	BL	
G	H	I	J	K	L	Bloomberg	353 BTV
M	N	O	P	Q	R	Boomerang	297 BOOM
S	T	U	V	W	X	Bravo	273 BRVO
Y	Z	1	2	3	4	BYU TV	374 BYU
5	6	7	8	9	0	Cable Response TV	243 CRTV
CLR	SPC	DEL				Cable Response TV INFO #2	268 IRTV

News Now

Thu 10:00a 11:00a - 11:30a TV-PG

Business/Financial, [2008]

Programs: 553 BTV

< News Now	Today	11:00a	353
Financial News Now	Today	11:30a	353
Investments	Today	12:00p	353
World of Finances	Today	12:30p	353
Financial News Now	Today	1:00p	353



Search by Keyword

You can use the keyword search to find programs that don't fit into the Title or Person search criteria. For example, if you are looking for a show about cats, use the word pad to spell out "cats".

In this case, you must write the complete word in order to obtain relevant results. **Be aware that the search engine looks through show titles and descriptions for the keyword as a separate word and even as a part of a word.** Thus, you can see in the example that Catskills Mountains was returned by the search even though it wasn't what the user was after.

Simple words like "cats" can give you a lot of errant results, so try to pick good keywords to get the best results. In some cases you can enter a phrase (for example "Wild Cats"), but it must be an exact match to the program guide information to appear in the search results. Usually, it is better to use single words.

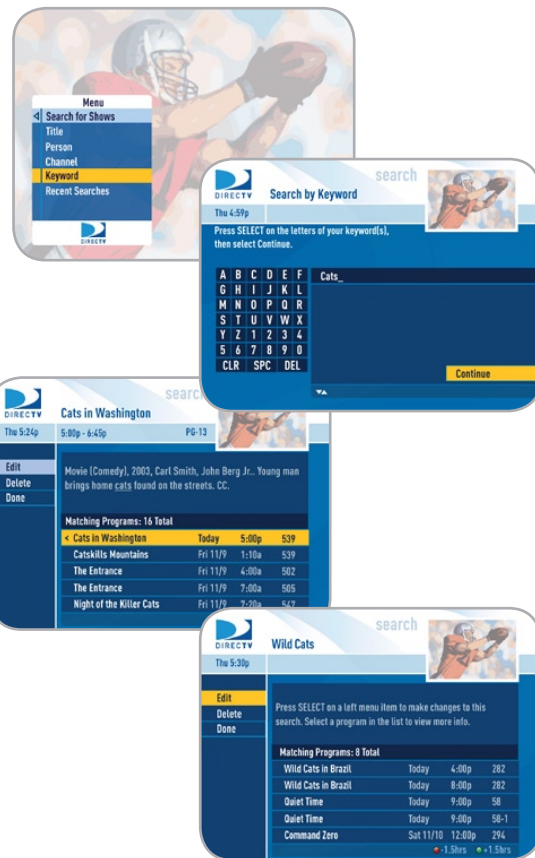

Recent Searches

This handy feature lets you go back to a list of your 25 most recent searches in case you want to update a search you used previously.



Main Menu - Manage Autotunes

“Manage Autotunes” is where you go to find the status of shows (past and future) that the receiver is set to tune to automatically (autotunes). Press MENU and select “Manage Autotunes” to see the following sections:

To Do List

“To Do List” contains all of the autotunes your receiver is set to make in the future. The icons next to the titles indicate whether the autotune is a single event, or part of a series, or an autotune based on a person or keyword search. The list is ordered by time with the next autotune at the top and the furthest in the future at the bottom. You can use this screen to make sure your autotunes are properly scheduled or to delete future scheduled autotunes.

Deleting single shows is easy, simply highlight the show you want to delete and press the RED button on the remote. A confirmation message will appear before you can delete the show.

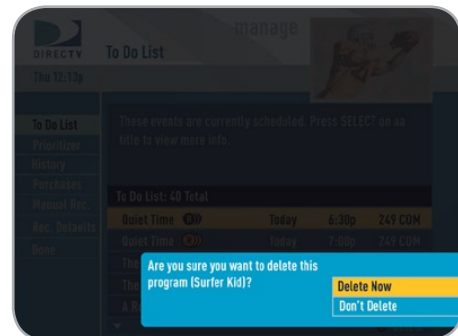
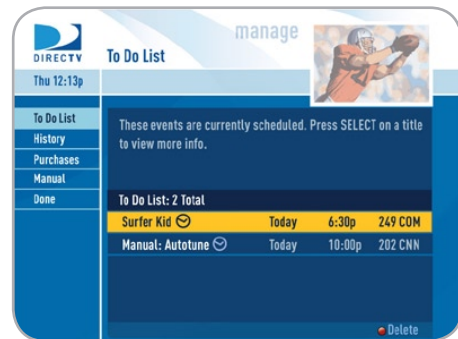

History

Provides status information for every autotune made, including those that were cancelled or deleted. If you think something should have been autotuned, but wasn't, check here to look for an explanation.

Purchases

Provides status information for all Pay Per View programs that were bought and the date and time they were viewed.

Manual Autotunes

Almost all of your autotunes can be done automatically by your receiver based on the show title, but there may be times when you want to set up a completely manual autotune based only on channel, time and date. In that case, select Manual and enter all of the options as you wish including whether you want this to be a one-time or recurring autotune (i.e. every Tuesday), channel, day and date, start time and duration. You can schedule a manual autotune up to 12 days in advance.

The image displays three screenshots of the DIRECTV 'manage' interface, arranged in a cascading fashion from top-right to bottom-left.

Top Screenshot: History
 Title: History
 Date: Sat 7:00p
 Menu: To Do List, History, Purchases, Manual, Done
 Description: This list includes up to 25 past scheduled events. Press SELECT on a title to view more info.
 Summary: History: 20 Total
 Table:

Surfer Kid	Today	6:30p	Tuned
Surfer Kid	Today	5:30p	Tuned
The Sport News	Today	10:00a	Tuned
The Sport News	Today	10:30a	Cancelled
Software Upgrade	Today	2:00a	Received

Middle Screenshot: Purchases
 Title: Purchases
 Date: Sat 7:30p
 Menu: To Do List, History, Purchases, Manual, Done
 Description: This list includes up to 25 past scheduled events. Press SELECT on a title to view more info.
 Summary: History: 9 Total
 Table:

Princess Esther	Fri 5/9	10:00p	Viewed
The J. Bee Street	Thu 5/8	8:30p	Viewed
Expressions of Love	Tue 4/29	10:00p	Viewed
Sadness & Happiness	Mon 4/28	9:00p	Viewed
Unforgiven Past	Sun 4/27	4:90p	Viewed

Bottom Screenshot: Manual
 Title: Manual
 Date: Thu 12:14p
 Menu: To Do List, History, Purchases, Manual, Done
 Description: Press SELECT on an option to change it, then select Set Autotune to schedule this time slot. A reminder will appear 2 minutes before start time.
 Form:
 Autotune:
 Channel:
 When:
 Start:
 Duration:
 Buttons: Autotune, Don't Autotune

- Chapter 1
- Chapter 2
- Chapter 3
- Chapter 4
- Chapter 5

Messages

DIRECTV sends messages to you via satellite for important news items or special promotions. We also summarize important software changes or new features that we download to your receiver. **When you have a new message in your folder the dark message icon will appear in the channel banner of any program you are watching.**

Simply press MENU, select Caller ID & Messages, then Messages to see your DIRECTV messages. You will have the option to keep or delete the message.

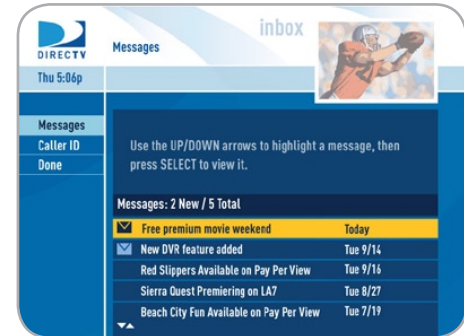

Caller ID

This section allows you to configure and review your Caller ID (if you have that phone service and your receiver is connected to the phone line). Set up your receiver to display Caller ID by selecting Caller ID & Messages from the main menu, then Caller ID, then navigate over to the Notification tab (or press the GREEN button for the shortcut), and select Notices: ON.

When the Notification option is on, you'll see a notice on your TV screen whenever a call comes in. You can review your 25 most recent calls in the call log at any time. Highlight and select a name to delete that listing from your log.

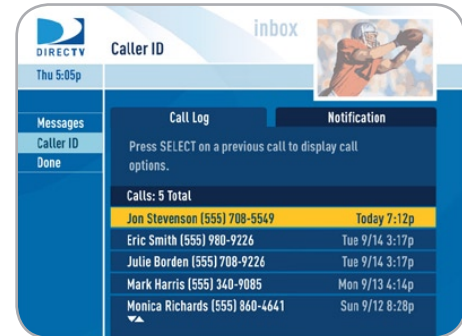
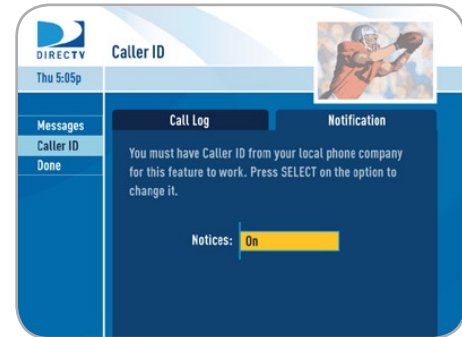

Main Menu - Customer Care & Help



Press MENU and select Customer Care & Help to access a list of Help topics and FAQs that explain how to use your receiver.

Help Topics and FAQs



To access the written Help Topics and FAQs, press MENU, then select "Customer Care & Help", then select "Help Topics".

Press SELECT on a folder to open it and press SELECT on the topic of your choice. If you want to go to the FAQ tab, press the GREEN button.

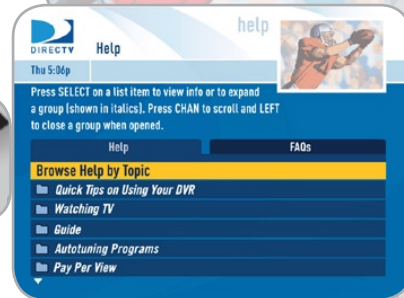
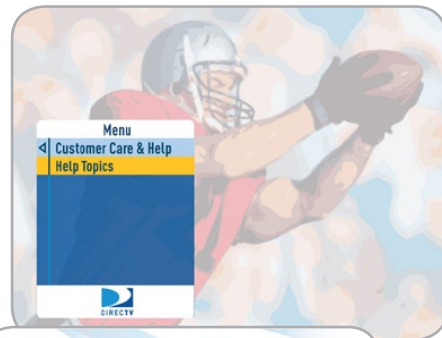

Selecting Parental, Fav's & Settings in the Main Menu displays a submenu of items that lets you customize and adjust your DIRECTV viewing experience. You can choose Parental Controls to limit what ratings your children are allowed to watch, how much they can spend for Pay Per View shows or even what hours they can watch DIRECTV programming. Choose Favorites to set up your own personal list of favorite channels and then use it in the program guide for a more customized experience. Select System Setup to adjust and configure how you want your TV and DIRECTV® System to work together.

Parental Controls

Parental Controls enables parents to place certain restrictions on just who's watching what, and require a passcode to view restricted programming. Whether it's for mature content, spending amounts, or even the number of hours of TV watching allowed, you're always able to keep limitations where you want them for the whole family.

Press **MENU**, **SELECT** Parental, Fav's & Settings, select **Parental Controls**, then **Edit Settings**, and you'll see the current status showing any restrictions. The system default is "unlocked" for all categories.

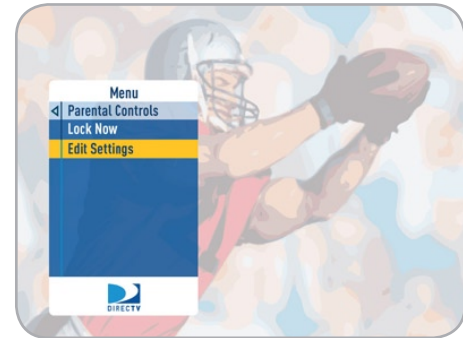
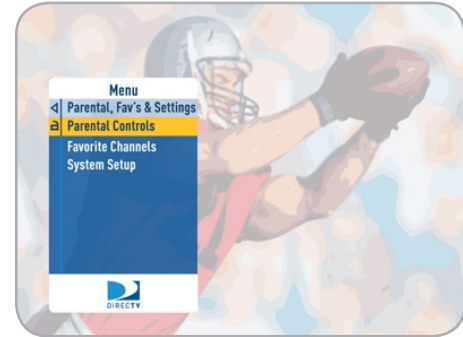

Ratings

Here you can set rating limits for Movies and TV:

1. Select Ratings.
2. Highlight the desired tab using the ARROW keys and press SELECT.

Note:

You can also use the RED or GREEN buttons to move between the tabs (movies, TV, other)



-Movies

Highlight and select the **Movies** tab, then set the overall rating limit you wish to impose. Brief descriptions of the ratings appear for your guidance.

-TV Programs

Select the TV tab, then highlight and select the TV rating you desire. You can also set ratings for particular content (for example, Fantasy, Violence, Dialogue), each of which is described when highlighted.

-Other Shows

To block programming that has no rating — such as news and sports — select the **Other** tab.

Channel Blocks

You can block viewing of a certain channel or channels using this menu. Select **Chan Blocks** in the left menu, then scroll down the channel list to select those you wish to block, or key in channel numbers for quicker access. Use Block All or Allow All to save time if you wish to affect a large number of channels.

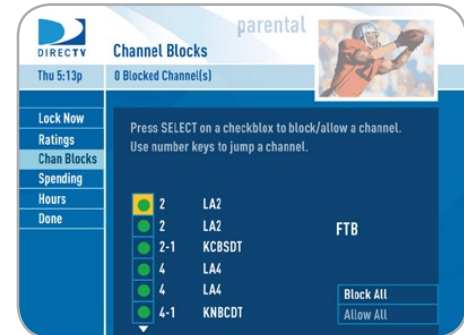

Limit Spending

From the left menu, select Spending, then set your preferred spending limit for any single Pay Per View purchase. Simply key in the amount using the numbers on your remote.

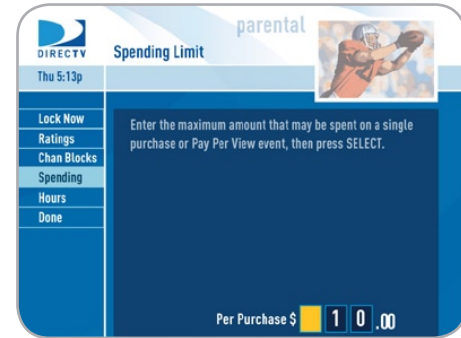

Limit TV Viewing Hours

From the left menu, select Hours, then set your preferred hours during which TV can be viewed. You can set hours based on "school nights" and weekend nights—Monday-Thursday, Friday-Saturday, and Sunday.

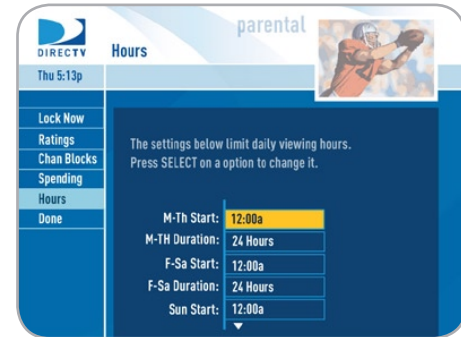

Now, lock it

Once you've set the restrictions you want, choose Lock Now from the left menu. You'll be directed to create a passcode (which you'll want to make easy enough to remember, but hard enough that the little ones won't guess it!). This passcode will be your entry to unlocking and adjusting limitations in the future.

An on-screen message will appear whenever anyone tries to tune to a channel or program that has been restricted, or attempts to spend or watch beyond limitations set. He or she will not be allowed to proceed without the passcode. Using your passcode, you can easily override the limits.

Let me in ...!

Temporarily or permanently unlocking a restriction is easy. To temporarily unlock a particular program:

1. When any controls are currently activated, Unlock Now will appear if you try to tune to a restricted program.
2. Select Unlock Now and enter the password.

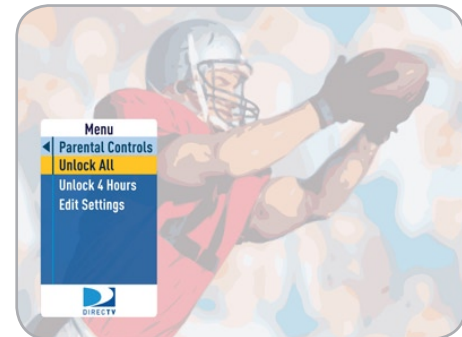

Main Menu - Parental, Fav's & Settings

For more unlock options:

1. Press MENU, then select Parental Fav's & Settings, then select Parental Controls.
2. Various options for removing restrictions temporarily or permanently will appear. Select one and enter your password.

Note:

If you have Parental Controls set and temporarily unlocked, turning the receiver off will turn the parental controls back on.

Making multiple entries aimed at guessing the passcode is discouraged by a time delay; each invalid passcode entered lengthens the delay for subsequent entry by one second.

To change your passcode at any time:

1. Press MENU, select Parental Controls, Fav's & Settings, then Parental Controls, then Edit Settings.
2. Scroll down to Passcode and press SELECT.
3. Enter your old password, then enter a new one twice to confirm.

Note:

If you forget your password, call 1-800-DIRECTV to reset it. You must be the registered account holder and have your account number.

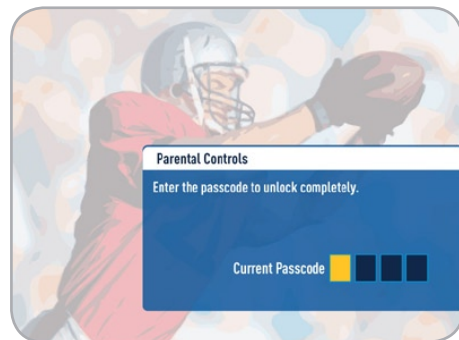

Favorite Channels

You can reach the favorite channels choices from the main menu or live TV. From the main menu select Parental, Fav's & Settings, then Favorite Channels. From live TV, press the YELLOW button, then select Change Favorites List. If you have not already created a Favorites list, the Setup Custom 1 and Setup Custom 2 options will be displayed.

Select the one you want, and follow the on-screen instructions to create and name your list. Once your list is created, if you press the YELLOW button while in the guide, the guide options menu will appear. Select Change Favorites List to pick the list you want to use in the guide.

Selecting a Favorites list makes it active and hides the display of all other channels in the guide. See the label in the bottom left of the program guide screen that reminds you which channel list you are currently using. To return to displaying all channels, press the YELLOW button while in the guide, select Favorites, and select the All Channels option.



System Setup

From System Setup you can access the Info & Test, Satellite & Antenna Setup, Remote Setup, Audio Setup, Display Setup, HDTV (if applicable), Access Card and System Reset screens.

Info & Test:

The System Info option lets you view the current system information. Press SELECT on Info & Test. Use the arrow key to go to the right and then scroll down to read the information. The System Info page will bring up a technical information screen that can be of help during troubleshooting. The front tab gives system information.

Use the ARROW button to go all the way to the top of the System Info page and then use the Right arrow (or press GREEN button) to change tabs to the System Test screen. The System Test option lets you run a test on the tuner, access card, receiver ID and phone line. Select Run Test to check out your system.

Note:

Running the System Test will interfere with live TV and any current autotunes.

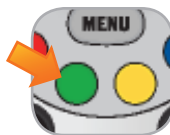
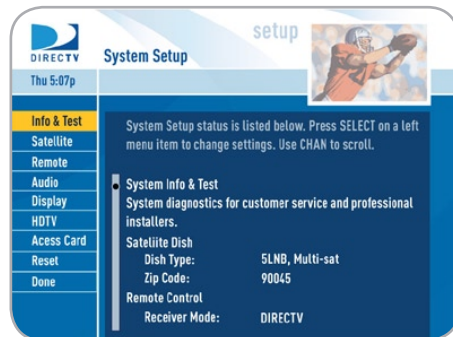

Satellite & Antenna:

This option is used by installers when your system is initially set up and you should not have to use it. However, you can come here to see the satellite signal strength your receiver is getting or to repeat the satellite setup procedure.

Remote - SD Receiver:

Use this option to set up your remote for your TV or auxiliary A/V equipment. Select AV1, AV2 or TV and follow the step by step instructions to set your remote to control your TV or other equipment A/V equipment like a DVD player or surround sound system.

It is best to know the model number as well as the brand of the equipment. It will produce the best results when programming the remote.

Select "Receiver Mode" to program your remote to control more than one DIRECTV® Receiver.

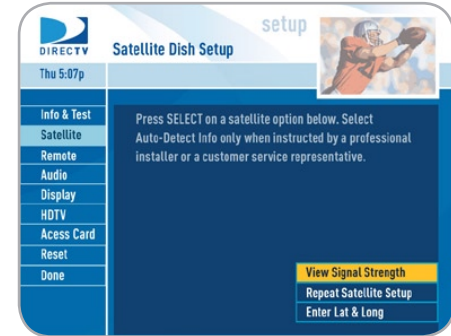

Remote - HD Receiver



You can also program your remote control to run other equipment as described above. In addition, if you have an optional RF remote, select IR/RF Setup to change your remote method of transmission from Infrared (IR) signals to Radio Frequency (RF). While IR transmission requires a clear line of sight to the front of the receiver, RF transmission lets you put your receiver inside a cabinet or behind solid doors and still be able to command it from up to 200 feet away. Select Receiver Mode if you want to use one remote to command more than one DIRECTV® Receiver.

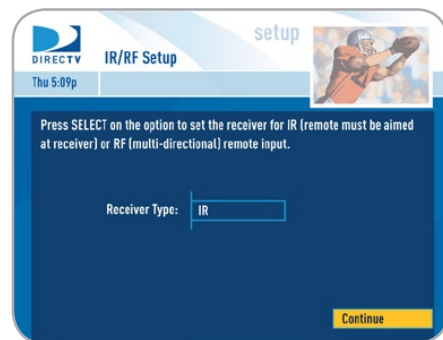

Audio:

The Audio option in Setup lets you make lasting adjustments to settings such as your preferred audio language.

To make temporary adjustments to your preferred audio language, use the Audio Options item from the Options menu in Live TV (or press GREEN from Live TV to cycle through the available audio tracks).

SD receivers only have one choice to make from this setup screen.

SD Receivers



HD Receivers

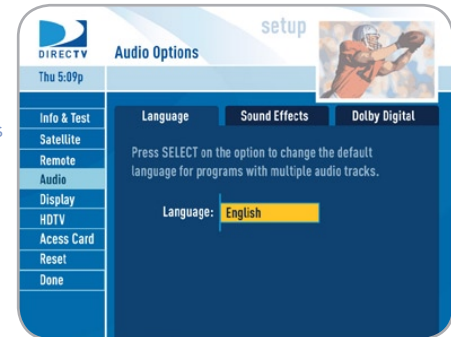

If you have an HD receiver you have three choices to make:

- Your preferred audio language
- How loud you want the sound effects on the receiver to be
- Whether you want Dolby Digital output (for a surround sound system, for example).

Not all TV programs deliver Dolby® Digital 5.1 channel signals. Look for the Dolby® Digital icon in the program description and Channel Banner.



HD Channels include 5.1 surround sound when available from programmer. Additional equipment required and sold separately. "Dolby" and the double-D symbol are trademarks of Dolby Laboratories.

Display - SD Receivers:

This important section allows you to customize how several pieces of important DIRECTV and system information are displayed on your TV. Choose the Preferences tab to:

- Set the channel banner time to determine how quickly the banner disappears after moving to a new channel.
- Choose your preferred on-screen text language.
- Choose whether you want the first press of the GUIDE button to take you directly to the program guide or to go to the category filter first. (No matter which one you choose, pressing GUIDE a second time shows you the other option.)

Move to the TV Ratio tab by using the arrow keys (or pressing the GREEN button) and select your TV Ratio. Most SD TVs are 4:3. HD TVs are 16:9.

Go to the Time Zone tab to set your time zone and whether you want the receiver to show Daylight Savings time or not.

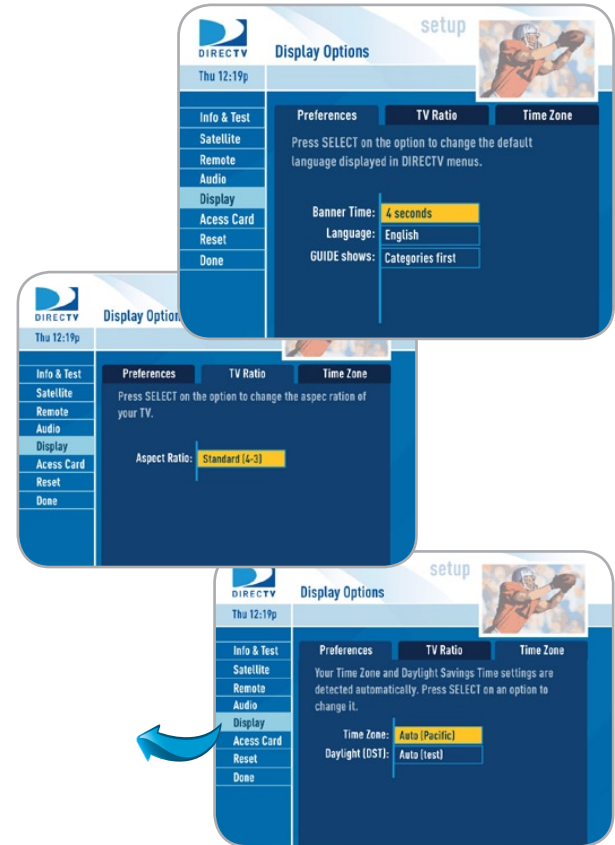

Display - HD Receivers:



This important section allows you to customize how several pieces of important DIRECTV and system information are displayed on your TV.

- Choose the Preferences tab to set whether you want lists in the program guide to display in smooth scrolling or in blocks as you page up and down.
- Set the channel banner time to determine how quickly the banner disappears after moving to a new channel.
- Choose your preferred on-screen text language.
- Choose whether you want the guide to show your HD channels and their duplicate SD channels or to hide the SD duplicates.
- Choose whether you want the first press of the GUIDE button to take you directly to the program guide or to go to the category filter first. (No matter which one you choose, pressing GUIDE a second time shows you the other option.)

Move to the Captioning tab by using the arrow keys (or pressing the GREEN button) and select your preferred options. You can customize how closed captioning appears, or whether it appears at all.

Move to the Centering tab to position the image on your TV screen.

Go to the Clock tab to set your time zone and whether you want the receiver to show Daylight Savings time or not.

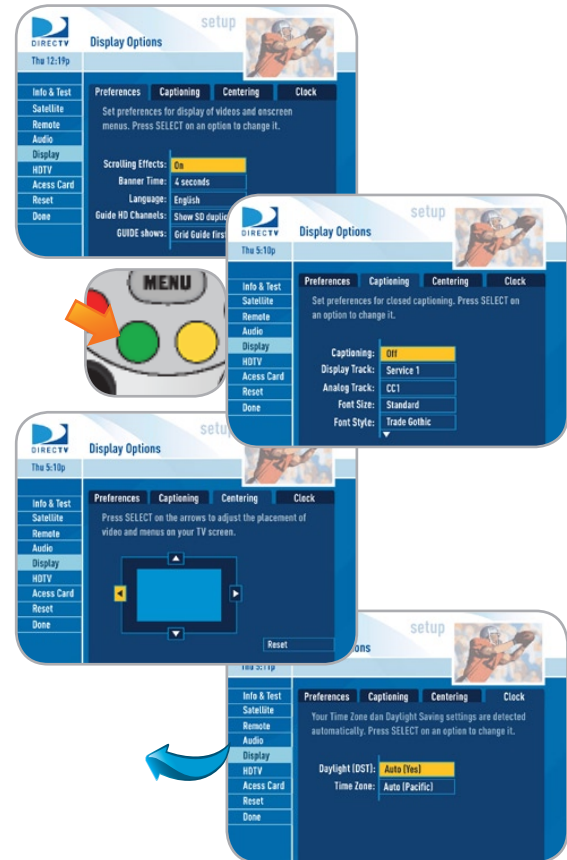

HDTV:



This section lets you optimize your HD Receiver output to match the settings on your HDTV. You may want to refer to Appendix 2 which describes HD formats and resolution before making any adjustments here.

The Video tab lets you set Native mode ON or OFF. Native Mode looks at the digital aspect ratio and resolution of the program coming into the receiver and sets your TV to the same format on-the-fly. For example, if your particular program is being broadcast in 4:3 aspect ratio and 720p resolution, your HD Receiver tells the TV to show it in that same format. If the next program changes to 16:9 and 1080i, the receiver tells the TV to change to that format. You do not need to choose Native mode because your HD Receiver will adjust and change the picture to fit your TV as described in the following paragraphs. In fact, Native Mode slows down the response of your system to channel changes because the receiver and TV must communicate at every channel change before the video comes up on the screen. Therefore, the default position is OFF, but you can override it if you wish.

Choose the screen format you prefer for the instances when the broadcast does not exactly fit your TV screen and the HD Receiver will automatically size it. For example, when viewing very wide format movies you can choose to have letterbox bars on the top and bottom of the screen. This preserves the proportions of the images on the screen. Or you can choose to stretch the images vertically to fill up the screen. If your HDTV is 4:3 aspect ratio, you may want to choose "crop" to cut off the content at the left and right side of the screen while preserving the proportion of the images that remain.

Choose the color of the bars you prefer when viewing an image in letterbox (or pillar) mode.

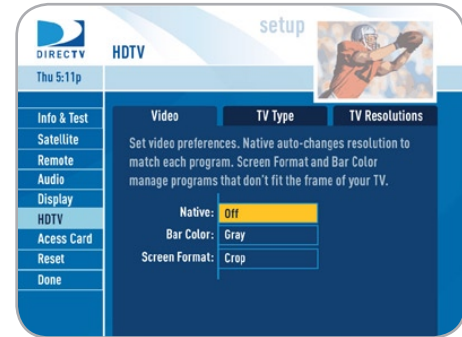



The TV Type tab lets you define the aspect ratio of the TV you are using with your receiver. Most HDTVs are 16:9.

Note:

You can move between the tab screens by pressing the GREEN button.

The TV Resolutions tab lets you define what resolutions your TV can support, so that your HD Receiver can pass the proper signal.

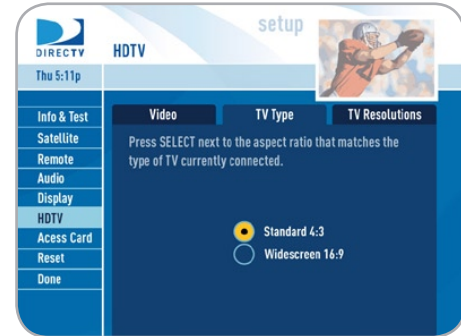

Access Card:

Follow the on-screen directions to replace your access card. You will need your old and new access cards to complete this process.

Note:

DIRECTV will provide new access cards and instructions when necessary.

Reset

From here you can restart the receiver, reset to factory defaults, or reset everything. Restarting the receiver is the same function as pressing the RED button behind the access card door on the front of the receiver. Restoring factory defaults erases all of your personal preference items and restores the receiver configuration to how it was set at the factory. "Reset Everything" completely erases everything from system memory and starts over like a new receiver.

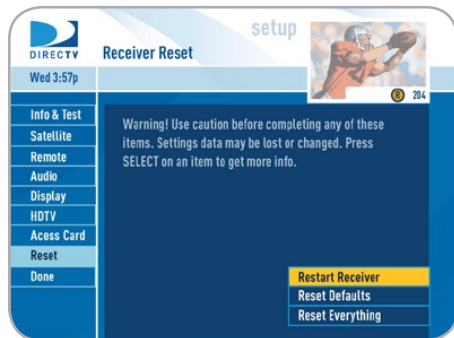

CHAPTER 3 - INSTALLATION AND CONNECTIONS

- YOUR PHONE CONNECTION58
- CONNECTIONS FOR AUXILIARY EQUIPMENT58
- GUIDED SETUP62
- ACTIVATE YOUR DIRECTV SERVICE62
- PROGRAMMING YOUR REMOTE CONTROL63

Installation and Connections

For the best user experience and system performance we highly recommend that your system be professionally installed. Call 1-800-DIRECTV to schedule an installation.

Your Phone Connection

Connecting your receiver to a land-based telephone line saves you money because it allows you to purchase Pay Per View movies and special events without calling DIRECTV to order. It is required for sports package subscriptions and is also used to enhance the interactive features available on our interactive channels. The receiver uses a toll-free number once a month for a few minutes' duration and is designed not to interfere with your regular phone service. You will need an RJ11-type modulator jack (the most common type of phone jack). If you disconnect the phone line, the receiver will not allow you to purchase PPV programs and some features of our interactive channels will be limited.

Do not connect your receiver to a digital PBX phone system — doing so may permanently damage your equipment and void your warranty.

Connections for Auxiliary Equipment

The following instructions apply if you are upgrading to a new TV or adding a surround sound system, DVD player/burner or VCR some time after your professional installation.

Due to restrictions imposed by copyright holders, certain programming may include content protection measures that may restrict viewing or recording with certain consumer electronics equipment attached to the receiver. Please contact the manufacturer of such equipment for additional information.

Not all cables come with your digital satellite receiver; you may need to purchase additional cables depending on your setup.

Note:

Never connect an IN to an IN or an OUT to an OUT. All A/V jacks and inputs are color coded. Always match the color of the plug to the same color of the jack.

Tip:

To obtain the best picture quality, make sure the receiver is connected directly to the TV.

All of the video and audio outputs on your receiver offer good quality. When adding new equipment, try to use the receiver video and audio output connectors in the following order to achieve the highest picture and sound quality throughout your audio/video system.

WARNING:

Do not connect your receiver (or any other equipment such as a TV or VCR) to the AC power supply until you have properly connected all the other cables.

Video Connections



- HDMI [High-Definition Multimedia Interface, one connector per receiver] provides the best digital video and digital audio in one connector.

- Component Video Output (YPbPr, one set per receiver) provides high-quality video, but does not provide audio. You will need to connect audio separately using the digital audio or RCA audio connectors.

- S-video (one connector per receiver) provides good video, but does not provide audio. You will need to connect audio separately using the digital audio or RCA audio connectors.

- RCA jacks (two sets per receiver) provide good video and usually come bundled with three cables for one video and two audio channels.

Audio Connections



- HDMI [High-Definition Multimedia Interface] provides the best digital video and audio in one connector.

- Digital Audio Optical (one connector per receiver) provides excellent quality digital audio and is often used on newer surround sound and DVD equipment.

- Digital Audio Coax (one connector per receiver) provides high quality digital audio and is also found on newer surround sound and DVD equipment.

- RCA jacks provide good audio quality and are found on older auxiliary equipment.

Because there are so many makes and models of TVs and auxiliary equipment, it is impossible to fully describe all the possible connections between your receiver and that equipment. Please refer to your TV and auxiliary equipment manuals for all of the connection options specific to each make and model. The following images show examples of how your receiver may be connected. In these examples, we try to use the best video connection that is supported by the TV, the best audio that is supported by the surround sound, and the next best video/audio connections on the DVD player/burner or VCR.



Example: TV with HDMI Connector

Here is an example using a TV that has an HDMI connector as the best video/audio input and a surround sound system that has a digital audio optical connector as the best audio input:

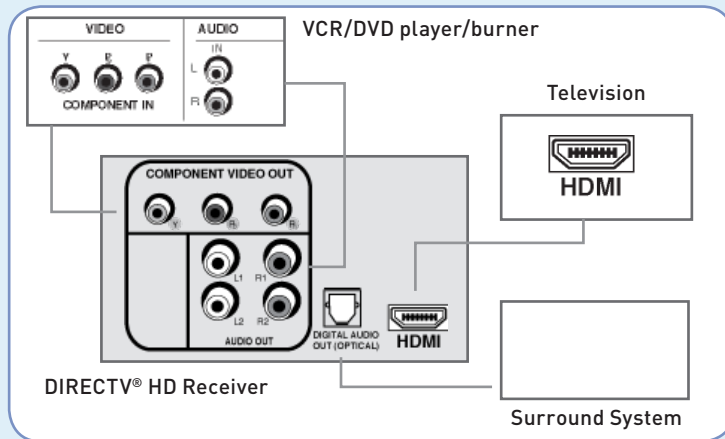

Example: TV with Component Video Connectors

Here is an example using a TV that has component video connectors as the best video input with RCA audio connectors as the best audio input and a surround sound system that has a digital audio coax connector as the best audio input:

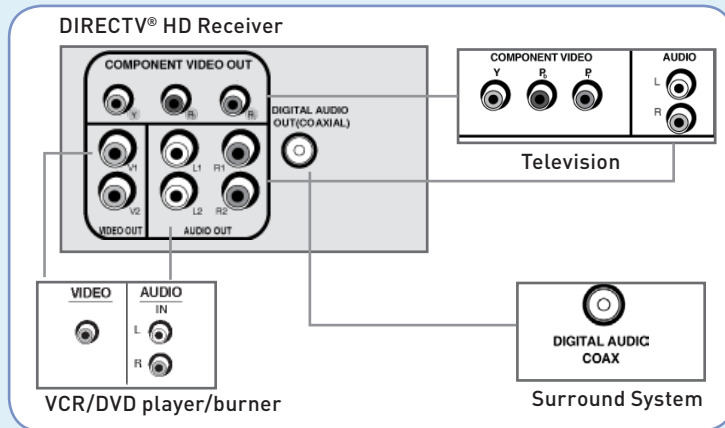



Example: TV with S-Video Connector

Here is an example of a TV that has an S-video connector as the best video input and RCA audio connectors as the best audio input and a surround sound system with a digital audio optical connector as the best audio input:

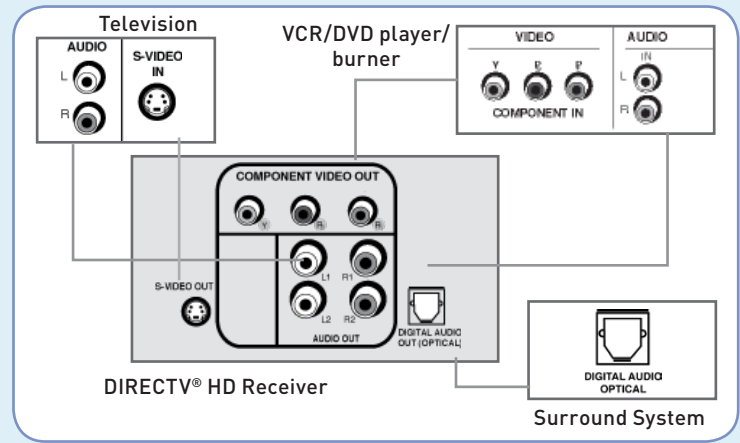

Example: TV with S-Video Connector

Here is an example of a TV that has an S-Video connector as the best video input and a VCR with RCA connectors as the best audio input:

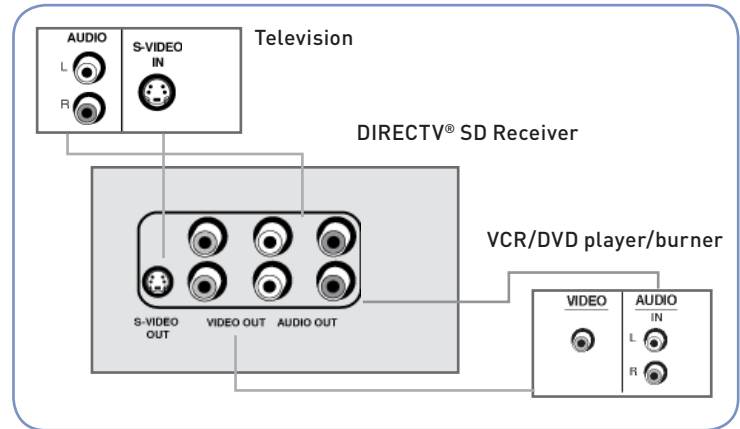

Chapter 1

Chapter 2

Chapter 3

Chapter 4

Chapter 5

Guided Setup

If your receiver was not professionally installed, you will need to follow the guided setup screens before starting DIRECTV Service.

1. Make sure the MODE switch at the top of the remote control is set to DIRECTV, which is the far-left position.
2. Press PWR. The DIRECTV® Receiver will turn on. (Make sure your TV is also turned on!)
3. The first screen will allow you to select a language. Using the arrow keys on the remote control, move to the language you prefer and press SELECT.
4. You will see a Welcome screen.

Simply follow the on-screen directions to complete your setup functions. If you've installed your satellite dish and system yourself, you'll be guided through various functions for optimizing your signal and setup — including positioning your dish and a system test. After these setup procedures are complete, you'll see a message on-screen that says, "Acquiring Satellite Info," as the receiver gathers information from the satellite for the on-screen program guide.

Next, you'll be given the opportunity to program your remote to control other equipment such as your TV and/or DVD player. Just follow the screen instructions and you'll be ready to watch in no time!

Activate Your DIRECTV® Service

Once all the setup processes are complete, all that's left to do is activate your DIRECTV Service. Before you make the call, be sure to: Have on hand your service address, social security number and a valid major credit card.

Note your access card and receiver ID numbers. (You may have written them down earlier in this chapter.)

When you're ready, just call 1-800-DIRECTV (1-800-347-3288) and pick the programming package that's right for you and subscribe to DIRECTV service.

Programming Your Remote Control

You may have already programmed your remote control during Guided Setup, but if you didn't, or you want to make changes, or you've acquired some new equipment, follow these instructions. You can program the DIRECTV Remote Control to operate your TV power, volume and mute, additional equipment such as a DVD, VCR, stereo, or second TV or DIRECTV® Receiver.

1. Press MENU to display the on-screen Menu.
2. Highlight "Parental, Fav's & Settings" and press SELECT.
3. Highlight "System Setup" and press SELECT.
4. Press SELECT on "Remote" in the left menu.
5. Follow the on-screen instructions to program your remote for your TV or additional equipment (AV1 and AV2).

Once your remote is programmed to work with your TV, the VOL and MUTE key control the TV regardless of the MODE slide switch position. If you would like to change the VOL and MUTE to work with other audio equipment, such as a stereo, you can. When you program the remote for the audio equipment, on-screen instructions will direct you on how to do this.

Factory Defaults

To reset the remote control and clear all but DIRECTV mode, follow these steps:

1. Point the remote away from your DIRECTV® Receiver and components. Press and hold MUTE and SELECT until the light above the slide switch on the remote flashes twice (about 5 seconds).
2. Enter 9-8-1. The light on the remote will flash twice, indicating you have cleared AV1, AV2 and TV modes.

CHAPTER 4 - TROUBLESHOOTING TIPS

● TROUBLESHOOTING TIPS	66
● DIRECTV® RECEIVER OR TV PROBLEMS	68
● REMOTE CONTROL PROBLEMS	75
● RUNNING THE SYSTEM TEST	76

Resetting / Reauthorizing Your Receiver

Many problems can be corrected by performing a simple reset of the DIRECTV® Receiver. If you experience frozen audio or video, blank screen, or the system won't respond to front panel button or remote control, try one of these:

- Press the RED RESET button behind the access card panel door on the front of the DIRECTV® Receiver, then wait for program guide information to be acquired.
- If the problems persist, try unplugging the power cord of the DIRECTV® Receiver for 15 seconds, then plug it in again.
- Try reauthorizing your receiver. From directv.com, click on Customer Service, Troubleshooting, On-Screen Messages, Please Call Customer Service, ext. 721. You will need to be logged into your account on directv.com to complete this process.
- Running the System Test (later in this section) can also help you diagnose and solve many common problems.



System Software Updates

DIRECTV periodically sends system software updates to your receiver to improve performance and upgrade features and functions. These updates will occur automatically, usually at times when the receiver would likely be turned off. If your receiver is on when an update is sent, you will see an on-screen message and you may experience a disruption in reception for a few minutes. Your reception should return to normal after the update is complete. Your receiver must be plugged in to AC power to receive any updates. Running the System Test (later in this section) can also help you diagnose and solve many common problems.

On-Screen Error Messages

There may be times when you see an on-screen error message similar to the one on the right. The top line of the message gives a brief description of the error, while the second line supplies an error code in parentheses. In this case, you would be trying to view a channel that you have not purchased or that is not in your programming package. If you want to resolve the error, **call Customer Service at 1-800-DIRECTV** and mention the error code number when prompted.

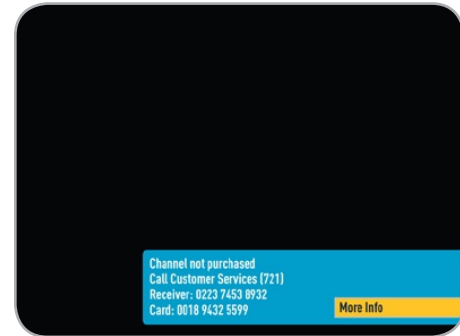

Problem: Progress bar freezes while Acquiring Guide Data / Data From Satellite

While Acquiring Guide Data / Acquiring Data From Satellite message is on the screen, progress freezes during download.

Possible Causes:

- This may be normal. After five minutes, the screen saver is displayed. Press any key on the remote to see the progress bar again.
- May happen if your satellite dish isn't adjusted properly.

Solution:

- If Satellite Data Acquisition still does not move forward, press the RESET button behind the access panel door on the front of the DIRECTV® Receiver and wait for program guide information to be acquired.

Problem: Wrong picture, blue screen, snow or black/blank picture

Your TV displays incorrect picture, or you have a blue, black, snowy or blank screen.

Possible Causes:

- The DIRECTV® Receiver and most TVs and VCRs let you toggle between different video sources.
- Your TV may be on a different input source than what you are trying to view.

Solution:

- If you don't see the signal you think you should be seeing, try using these buttons to toggle between the signals:
 - Press the TV/VCR button on the VCR remote or on the VCR's front panel.
 - Press the INPUT button on the TV remote control to change video source.
- If problems persist, turn off all equipment that is connected to your TV, wait a few minutes, then turn the DIRECTV® Receiver back on.
- Check your connections and cables.

Problem: Caller ID not working

Caller ID information isn't showing on your TV screen when phone calls come in.

Possible Causes:

- You don't subscribe to Caller ID service through your local phone company.
- The Caller ID feature in your DIRECTV® Receiver is turned off. See "Caller ID & Messages" in Chapter 2.
- You are using a wireless phone jack, which usually will not transmit Caller ID information.

Solution:

- Contact your local phone company to subscribe to Caller ID service.
- Select Caller ID & Messages from the Main Menu to turn on your Caller ID notifications.
- Verify that your wireless phone jack transmits Caller ID information. If not, connect a standard phone cable to your receiver or replace your wireless phone jack.

Problem: DIRECTV® Receiver will not turn on

Your receiver won't turn on with either the remote or from the front panel.

Possible Causes:

- Remote batteries are dead.
- Receiver or power strip is not plugged in to a power source, or power cord is not plugged in to receiver.
- Wall outlet is dead.

Solution:

- Make sure the remote control mode switch is in the left-most position (DIRECTV mode), and press PWR (power key) or press POWER button on the front panel of the receiver
- Verify that the power cord is plugged into the DIRECTV® Receiver and the wall outlet.
- Check the outlet or power strip to make sure it is "live" by plugging in something else.
- Replace batteries in remote control.

- Be sure remote is pointed at remote sensor on receiver, and sensor is not blocked.
- Try plugging receiver into a different wall outlet.
- Unplug receiver for five minutes, and then plug it in again.
- Press TV POWER ON. Press it again, if needed.
- Check / reset power strip, if needed

Problem: DIRECTV® Receiver Turns off while playing

Your receiver turns off unexpectedly.

Possible Causes:

- Excessive heat may have caused the receiver to go into a standby state.
- Electronic protection circuit may have been activated due to a power surge.
- You may have blown a circuit breaker or be experiencing a power outage.
- Parental viewing limits may have been activated on your DIRECTV® Receiver.

Solution:

- Ensure that your receiver has plenty of ventilation and that nothing is on top of the receiver.
- Wait 30 seconds for internal circuits to reset, then turn receiver back on.
- Check the circuit breakers in your home.
- Consider using a line conditioner or surge protector.
- Consult an electrician if the problem is frequent or severe, especially if other household appliances or electronics are affected.
- If parental limits are active, turn your DIRECTV® Receiver back on and enter your parental lock code at the prompt.

Problem: DIRECTV® Receiver turns on or changes channels unexpectedly

Your receiver changes to a different channel without a remote control command.

Possible Causes:

- A scheduled autotune may be about to begin, so the receiver is changing channels to tune the show as requested.
- Your TV's timer may have been activated.

Solution:

- Check your To Do List to see if there are other scheduled autotunes (press MENU, select Manage Autotunes, then To Do list).
- Check your TV owner's manual to turn off the TV's timer.

Problem: Blank screen

There is nothing on your TV screen.

Possible Causes:

- Your TV and/or your receiver are not powered on.
- Your receiver may be hooked up to the TV incorrectly.
- You may be on the wrong video source for your DIRECTV® Receiver.
- You may be tuned to a channel that is not currently broadcasting, or that you don't subscribe to.

Solution:

- Check that DIRECTV® Receiver and TV are both powered on.
- Check the Installation and Connections (Chapter 3) section of this manual for instructions about connecting your receiver.
- Press the INPUT button on the TV remote control to change video source.
- Try another channel and see if you have live video.
- Press the POWER button on the front panel of the DIRECTV® Receiver.
- Press the red RESET button behind the door on the front panel of the receiver.

Problem: Temporary loss of the satellite signal, Searching for Satellite Signal, “frozen” picture, or picture breaks into blocks / pixels

The image on your screen is frozen, blocky, or you see a message that says Searching for Satellite Signal (x 771).

Possible Causes:

- Severe weather (rain, snow, hail etc.) may cause this issue.
- There may be an obstruction to your dish (debris, snow, ice, etc.) or a building or tree that blocks your line of sight to the satellite.
- There may be a problem with the cables running from your satellite dish to your DIRECTV® Receiver.
- If the picture is frozen, blocky, or pixels, there may be a problem with the transmission from the source.
- The five-minute free preview of a PPV movie may have expired.

Solution:

- Weather issues are usually temporary. Wait for the weather to clear and your signal should return to normal.
- If there are no weather problems in your area, reset your DIRECTV® Receiver using the red RESET button behind the door on the front of the receiver or by unplugging the receiver for 15 seconds and then plugging it back in.
- You can also check all the cable connections between your DIRECTV® Receiver and the satellite dish for loose or broken connections.
- If the problem is coming from the program source, wait for the broadcasting channel to resolve the issue.
- Purchase the PPV movie to continue watching the program.
- If there are obstructions blocking the dish's clear view of the satellite, you should contact a professional to remove them or a DIRECTV installer at 1-800-531-5000 to relocate your dish.
- If your signal strength is lower than 70 (60 or lower on HD receivers) on most transponders in good weather, contact a professional installer to realign your dish or call us at 1-800-531-5000.

Problem: Partial programming loss/channels missing from the Guide/Channel is in the Guide but I can't tune to it.

You have lost channels in your Program Guide, or are unable to use the guide to tune to a channel.

Possible Causes:

- The channels might be excluded from the Favorites list currently in use.
- Your satellite dish may be incorrectly configured.
- Your receiver information may need to be refreshed.

Solution:

- To change your Favorites List, press GUIDE on the remote, then press the YELLOW button and select Change Favorites List, then All Channels. Or you can enter the channel number manually.
- To check the dish type set in your receiver's preferences, press the MENU key on the remote control, then select Parental, Fav's & Settings, then System Setup. In the next menu, select Sat & Ant, then Repeat Satellite Dish Setup. Follow the steps. From the Satellite Dish Type screen, make sure the proper dish type is selected (round, oval with a dual-LNB or oval with a 5-LNB).
- To refresh your receiver information, go to directv.com, click on Customer Service, Troubleshooting, On-Screen Messages, Please Call Customer Service, ext. 721. You will need to be logged into your account on directv.com to complete this process.

Problem: My video and audio are out of sync.

The audio track does not match the lip movements on the screen.

Possible Causes:

- Problem with how the program was produced or how it was sent to DIRECTV for broadcast.
- Your surround sound system may be out of sync, or may be set up incorrectly.

Solution:

- Change the channel on your DIRECTV® Receiver. This may re-synch the audio.
- Try changing the cables from your surround sound system to your receiver. Refer to your surround sound system's manual for assistance.
- If the issue continues, reset your DIRECTV® Receiver. Press the RESET button behind the access panel door on the front of the DIRECTV® Receiver. You can also press MENU, press SELECT on Parental, Fav's & Settings, then select System Setup. Select the Reset item from the left menu and follow the on-screen instructions.

Problem: No Audio with Picture

You can see a picture from your DIRECTV® Receiver, but there is no sound.

Possible Causes:

- If you have had sound from this receiver in the past, it is likely a setting has changed on the receiver or your TV.
- If this is a new setup and you have not had sound, check the cables between your TV and the receiver.
- Verify that your surround sound system is working, if applicable.

Solution:

- Verify "MUTE" button not activated.
- Raise or lower the volume. Did volume meter display on TV?
- Test sound on TV by changing the input to another source, such as a DVD player, game box, or antenna.
- If connected to stereo, make sure stereo is on and set to the correct mode.
- Verify audio cables are secure and connected correctly.
- If the issue continues, reset your DIRECTV® Receiver. Press the RESET button behind the access panel door on the front of the DIRECTV® Receiver. You can also press MENU, select Parental, Fav's & Settings, then select System Setup. Select the Reset item from the left menu and follow the on-screen instructions.

Remote Control Solutions

- Check that nothing is between the remote control and the remote sensor.
- Make sure the remote control is in DIRECTV mode. Slide the MODE switch on the remote to the DIRECTV position so the remote will control the DIRECTV® Receiver.
- Check the batteries in the remote control. They may be weak, dead or installed incorrectly. Try replacing batteries.
- If you're entering a channel number that is less than four digits long, the receiver might wait two seconds before tuning to the channel. Press ENTER after entering a channel number to tune immediately.
- If you are trying to operate a device other than the DIRECTV® Receiver that you have programmed the remote to control, make sure you first slide the MODE switch to the mode that is programmed for that device (AV1 or AV2). The indicator light for the component you're trying to control should light up when you press a valid key for that component. If it doesn't, make sure the MODE switch is in the correct position.
- Make sure the device you are trying to control has been programmed to your DIRECTV remote control. See Chapter 3 of this manual for instructions on how to program your remote to control other devices.
- If the indicator lights on the remote control start flashing, the batteries in the remote control are running low and should be replaced soon. You may also see an on-screen message that the batteries are low. Note that when you replace the batteries, you should not have to reprogram your remote to control other devices unless the batteries have been completely dead for a month or more.

Running the System Test

The System Test allows you to run a basic diagnostics check on your DIRECTV Receiver. If you are experiencing any trouble with your receiver, run the system test. It will also allow you to get your access card and receiver ID numbers or to initiate diagnostic procedures on your digital satellite receiver.

First make sure that:

- All connections — jacks, cables, etc. — are in place correctly (see Chapter Three, Installation and Connections, for more information)
- There are batteries in the remote control, and they are working correctly
- The access card is installed in the DIRECTV Receiver.

Follow these steps to run the diagnostics system test on your DIRECTV Receiver.

1. Turn on your TV and the DIRECTV® Receiver.
2. Slide the mode switch to the DIRECTV position to put the remote control in satellite receiver-controlling mode, then press MENU to display the Quick Menu.
3. Select Parental, Fav's & Settings.
4. Select System Setup, then Info & Test.
5. Highlight the System Test tab and press SELECT, then press SELECT on Run Test.
6. If your system does not pass the System Test, check any of these potential trouble areas: cabling, pointing the satellite dish, phone connection and access card.
7. If you continue to have problems, call DIRECTV Customer Service at 1-800-DIRECTV.
8. You should run a system test several times before concluding that there is a problem. Occasional fluctuations in the phone line or satellite signal can give temporary false readings.

CHAPTER 5 - WARRANTY AND OTHER INFORMATION

● LIMITED 90-DAY WARRANTY	78
● PRODUCT INFORMATION	81
● DIRECTV PROTECTION PLAN	82
● FCC CUSTOMER INFORMATION	84
● TERMS & CONDITIONS FOR USE OF SOFTWARE	88

Limited 90-Day Warranty

DIRECTV warrants your DIRECTV® Receiver (Model Number: H21 and D12) and any included accessories against defects in material or workmanship for a period of ninety (90) days after the date of acquisition.

Who is Covered?

You must have proof of acquisition to receive warranty service. A receipt or other document showing that you acquired the product is considered proof of acquisition. THIS LIMITED WARRANTY EXTENDS ONLY TO THE ORIGINAL CONSUMER ACQUIRER OR ANY PERSON RECEIVING THE DIRECTV® RECEIVER AS A GIFT FROM THE ORIGINAL CONSUMER ACQUIRER AND TO NO OTHER ACQUIRER OR TRANSFEREE. THIS WARRANTY DOES NOT EXTEND TO COMMERCIAL USERS. THIS PRODUCT IS NOT AUTHORIZED FOR USE OUTSIDE THE UNITED STATES AND ANY SUCH USE VOIDS THIS WARRANTY.

What is Covered?

Warranty coverage begins the day you acquire the product. For ninety (90) days from the acquisition date, at the option of DIRECTV, the DIRECTV® Receiver will be repaired or replaced with a new, repaired, refurbished or comparable product (whichever is deemed necessary) if it becomes defective or inoperative. This exchange is done without charge to you for parts and labor. You will be responsible for the cost of shipping to and from the location designated by DIRECTV. If DIRECTV cannot reasonably repair or replace the Receiver then DIRECTV may, at its sole discretion, refund the price you paid for the product or the current retail price of the product.

All products, including replacement products, are covered only for the original warranty period. When the warranty on the original product expires, the warranty on the replacement product also expires. After ninety (90) days from the date of acquisition, you pay for the replacement of all parts, and for all labor charges.

SOME STATES DO NOT ALLOW LIMITATIONS ON HOW LONG AN IMPLIED WARRANTY LASTS, SO THE ABOVE LIMITATION MAY NOT APPLY TO YOU.

What is Excluded?

Your warranty does NOT cover:

Labor charges for installation or setup of the product.

Installation, performance of, or repair of: audio/video cabling, telephone line, or accessory attachments used with the product.

Product replacement because of misuse, accident, lightning damage, unauthorized repair, or other cause not within the control of DIRECTV.

Incidental or consequential damages resulting from the product. SOME STATES DO NOT ALLOW THE EXCLUSION OF INCIDENTAL OR CONSEQUENTIAL DAMAGES, SO THE ABOVE EXCLUSION MAY NOT APPLY TO YOU.

Any modifications or other changes to the product, including but not limited to software or hardware modification in any way other than as expressly authorized by DIRECTV will void this limited warranty. Except in the case of hardware or software provided by DIRECTV, installing software modifications, “hacks” or utilizing service access or “back doors” will void this limited warranty.

Reception transmission problems caused by signal conditions, telephone line, or cable or antenna systems outside the unit.

A product that has been modified or adapted to enable it to operate in any country other than the country for which it was designed, manufactured, approved and/or authorized, or repair of products damaged by these modifications.

A product used for commercial or institutional purposes.

DIRECTV makes no warranty that the access connection will be a local (not long distance) phone call.

The continued provisioning of any of the programming and other services delivered through the Receiver including but not limited to television programming, show information, program guide data, and scheduling information.

Make Sure You Keep...

Please keep your receipt or other document showing proof of acquisition. Attach it to this User Guide and keep both nearby. Also keep the original box and packing material in case you need to return your product.

Before Requesting Repair Service...

Please check the troubleshooting section of this guide. This may save you a call to DIRECTV Customer Care.

To Get Warranty Service...

Warranty service will be provided by DIRECTV. If you believe you need service for your Receiver, contact DIRECTV at 1-800-DIRECTV. A representative will go through a diagnostic checklist with you. If it is determined that the product needs to be returned for service or exchanged, you will receive a return authorization number. The representative will give you complete shipping details.

To Get Out-of-Warranty Service...

To obtain out-of-warranty service contact DIRECTV at 1-800-DIRECTV for information on the possibility of and any costs for repair or replacement of out-of-warranty products.

ALL WARRANTIES IMPLIED BY LAW, INCLUDING ANY IMPLIED WARRANTIES OF MERCHANTABILITY AND FITNESS FOR A PARTICULAR PURPOSE ARE EXPRESSLY LIMITED TO THE DURATION OF THIS EXPRESS LIMITED WARRANTY.

WITH THE EXCEPTION OF ANY WARRANTIES IMPLIED BY THE LAW OF ANY STATE OF THE U.S.A., THIS EXPRESS LIMITED WARRANTY IS EXCLUSIVE AND IN LIEU OF ALL OTHER WARRANTIES, GUARANTEES, AGREEMENTS AND SIMILAR OBLIGATIONS OF DIRECTV. REPAIR OR REPLACEMENT AS PROVIDED IN THIS LIMITED WARRANTY IS THE EXCLUSIVE REMEDY UNDER THIS LIMITED WARRANTY. IN NO EVENT WILL DIRECTV BE LIABLE FOR ANY AMOUNT GREATER THAN THE RETAIL PRICE OF THE DIRECTV® Receiver. DIRECTV SHALL NOT BE LIABLE FOR ANY INCIDENTAL OR CONSEQUENTIAL DAMAGES FOR BREACH OF ANY EXPRESS OR IMPLIED WARRANTY ON THE DIRECTV® RECEIVER.

SOME STATES DO NOT ALLOW LIMITATIONS ON WARRANTIES, SO THE ABOVE LIMITATIONS MAY NOT APPLY TO YOU. THIS WARRANTY GIVES YOU SPECIFIC LEGAL RIGHTS. YOU MAY HAVE OTHER RIGHTS WHICH VARY FROM STATE TO STATE.

DIRECTV, Inc.
2230 E. Imperial Hwy
El Segundo, CA 90245
1-800-DIRECTV

Keep your receipt to obtain warranty parts and service and for proof of acquisition. Attach it here and record the serial and model numbers in case you need them. These numbers are located on the product. (You may have noted some of this information when you connected the cables to your receiver.)

Model No.	
Serial No.	
Acquisition Date:	
Dealer/Address/Phone:	
Access Card:	
Receiver ID:	

DIRECTV PROTECTION PLAN

Safeguard your DIRECTV® System with the ULTIMATE in professional technical service. For a low monthly fee, the DIRECTV PROTECTION PLAN covers the components of your entire DIRECTV® System, giving you affordable peace of mind and comprehensive support to ensure that you and your family enjoy nonstop DIRECTV® entertainment.

DIRECTV PROTECTION PLAN Benefits

Your DIRECTV Limited Warranty provides certain remedies for this receiver during the stated coverage term. The DIRECTV PROTECTION PLAN provides comprehensive coverage for your DIRECTV® System, including:

Professional In-home service calls when needed	Dedicated Technical Support 24-hour a day
Power surge related repairs including those caused by lightning	Unlimited dish antenna alignments
Cables, switches, and associated wiring throughout your home	Replacement of defective receiver equipment (if problem can not be resolved over the phone)*
Defective remote control replacements	All parts and labor for repair

All this for one low monthly fee covers every DIRECTV Component and Receiver on your account.

Sign up today for the DIRECTV PROTECTION PLAN by calling 1-800-DIRECTV

The DIRECTV PROTECTION PLAN is offered by AIG Warranty Guard and underwritten by New Hampshire Insurance Company on behalf of DIRECTV where authorized by law. Certain limitations may apply. Pricing, terms and conditions of the DIRECTV PROTECTION PLAN are subject to change. Full terms and conditions will be mailed to you prior to service billing and are available at directv.com/protection. (Note: Annual payment option not available.)

This device complies with Part 15 of the FCC Rules. Operation is subject to the following two conditions: (1) this device may not cause harmful interference, and (2) this device must accept any interference received, including interference that may cause undesired operation.

Responsible Party:

DIRECTV, Inc.

2230 E. Imperial Hwy

El Segundo, CA 90245

1-800-DIRECTV

- Trade Name: DIRECTV
- Type of Equipment: DIRECTV Satellite Receiver
- Model Number: D12 or H21

Federal Communications Commission (FCC): This equipment complies with both Part 15 and Part 68 of the FCC rules.

This equipment has been tested and found to comply with the limits of a Class B digital device, pursuant to part 15 of the FCC Rules.

These limits are designed to provide reasonable protection against harmful interference in a residential installation.

This equipment generates, uses, and can radiate radio frequency energy and, if not installed and used in accordance with the instructions, may cause harmful interference to radio communications. However there is no guarantee that interference will not occur in a particular installation. If this equipment does cause harmful interference to radio or television reception, which can be determined by removing and applying power to the equipment, the user is encouraged to try to correct the interference by one or more of the following measures:

- Reorient or relocate the receiving satellite dish antenna.
- Increase the separation between the equipment and the DIRECTV® Receiver.
- Connect the equipment into an outlet on a circuit different from that to which the DIRECTV® Receiver is connected.
- Consult the dealer or an experienced radio/TV technician for help.
- CAUTION: Changes or modifications not expressly approved by the manufacturer responsible for compliance could void the user's authority to operate the equipment.

The user may find the following booklet, prepared by the Federal communications Commission, helpful: "How to Identify and Resolve Radio and TV Interference Problems." This booklet is available from the U.S. Government Printing Office, Washington, DC. To meet FCC requirements, only peripherals (computer input/output devices, terminals, printers, etc.) certified to comply with Class B limits may be attached to this device. Operation with non-certified peripherals is likely to result in interference to radio and TV reception. To meet FCC requirements, shielded cables are required to connect the device to a personal computer, peripheral, or other Class B certified device. This equipment complies with Part 68 of the FCC Rules and the requirements adopted by ACTA. On the back of this equipment is a label that contains a product identifier in the format US:AAAEQ##TXXXX.

If requested, this information must be provided to your telephone company. This equipment uses the following USOC Jack: RJ11C. A plug and jack used to connect this equipment to the premises wiring and telephone network must comply with the applicable FCC Part 68 rules and requirements adopted by ACTA. A compliant telephone cord and modular plug is provided with this product. It is designed to be connected to a compatible modular jack that is also compliant.

See installation instructions for details.

The REN is used to determine the number of devices that may connect to a telephone line. Excessive RENs on a telephone line may result in the devices not ringing in response to an incoming call. In most but not all areas, the sum of the RENs should not exceed five (5.0).

To be certain of the number of devices that may be connected to a line, as determined by the total RENs, contact your local telephone company. The REN for this product is part of the product identifier that has the format US: AAAEQ##TXXXX. The digits represented by ## are the REN without the decimal point (e.g., 03 is a REN of 0.3).

If this DIRECTV® Receiver causes harm to the telephone network, the telephone company will notify you in advance that temporary discontinuance of service may be required. But if advance notice isn't practical, the telephone company will notify the customer as soon as possible. Also, you will be advised of your right to file a complaint with the FCC if you believe it is necessary.

The telephone company may make changes in its facilities, equipment, operations or procedures that could affect the proper functioning of your equipment. If they do, you will be notified in advance in order for you to make necessary modifications to maintain uninterrupted service. Connection to party line service is subject to state tariffs. Contact the state public utility commission, public service commission or corporation commission for information.

If trouble is experienced with this unit, for repair or warranty information, please contact DIRECTV Customer Care at the address and phone number listed below. If the equipment is causing harm to the network, the telephone company may request that you disconnect the equipment until the problem is resolved.

DIRECTV, Inc.

2230 E. Imperial Hwy

El Segundo, CA 90245

1-800-DIRECTV

If your home has specially wired alarm equipment connected to the telephone line, ensure the installation of this DIRECTV Satellite Receiver does not disable your alarm equipment. If you have questions about what will disable alarm equipment, consult your alarm company, telephone company or a qualified installer.

DO NOT DISASSEMBLE THIS EQUIPMENT. It does not contain any user-serviceable components.

We recommend the installation of an AC surge arrester in the AC outlet to which this equipment is connected. Telephone companies report that electrical surges, typically lightning transients, are very destructive to customer terminal equipment connected to AC power sources.

TERMS AND CONDITIONS FOR USE OF SOFTWARE (“TERMS”)

THE DIRECTV® Receiver INCORPORATES SOFTWARE WHICH IS OWNED BY DIRECTV, INC. (“DIRECTV”) OR ITS THIRD PARTY LICENSORS (the “Software”). BEFORE USING THE RECEIVER PLEASE READ THESE TERMS. IF YOU DO NOT AGREE TO THESE TERMS YOU MAY NOT USE THE RECEIVER AND SHOULD IMMEDIATELY RETURN THE RECEIVER TO DIRECTV OR YOUR SUPPLIER. THESE TERMS ALSO APPLY TO ANY MODIFICATIONS, UPDATES OR SUPPLEMENTS TO THE SOFTWARE PROVIDED TO YOU.

A. License Grant and Conditions

DIRECTV grants you a non-exclusive, non-transferable, limited license to use the Software solely in executable code form and solely as integrated with, incorporated into, and in conjunction with the Receiver. You must ensure that the copyright, trademark and other protective notices contained in the Software are maintained and not altered or removed. The Software is protected by copyright and other laws and international copyright and other treaties. All title and intellectual property rights in and to the Software and all modifications, updates, enhancements and derivative works of the Software are owned exclusively by DIRECTV or its licensors and you agree to execute any document reasonably requested by DIRECTV to evidence such ownership rights. Certain third party software used in connection with the Receiver may be made directly available to you by the providers thereof. Use of such Software is also subject to the terms of any applicable agreement between you and each such provider. DIRECTV reserves the right to modify, supplement, update and otherwise alter the Software via software download or other modification procedures, and these terms will apply to such Software as modified, supplemented, updated, and otherwise altered.

B. License Restrictions

You may not copy, modify or transfer the Software, or any copy thereof, in whole or in part. You may not reverse engineer, disassemble, decompile or translate the Software, or otherwise attempt to derive the source code of the Software, except to the extent allowed under any applicable law. Any attempt to transfer any of the rights, duties or obligations of this license agreement is void. You may not rent, lease, load, resell for profit or distribute the Software, or any part thereof. You may not export, transfer or re-export the Software in violation of any applicable law. The Software may include some components that are covered by “free software” licenses, open source licenses and other similar license use rights, which require such components to be used, modified and/or distributed only under the terms of such licenses.

Any such components are subject only to the terms of such licenses, and not these Terms.

C. Ownership of Software and Reservation of Rights

The Software is licensed, not sold, to you for use only under the terms of this license agreement, DIRECTV is NOT transferring title or any ownership rights in the Software to you and DIRECTV and its suppliers reserve all rights not expressly granted to you. Except as stated above, this license agreement does not grant to you any intellectual property rights in the Software.

D. Termination

These Terms are effective until terminated. You may terminate these Terms by returning the Receiver to DIRECTV or your supplier. These Terms will terminate automatically without notice if you fail to comply with these Terms or any other agreement between you and DIRECTV. Upon termination you must return the Receiver to DIRECTV or your supplier.

E. Disclaimer

THE SOFTWARE IS (TO THE EXTENT PERMITTED BY LAW) SUPPLIED “AS IS”. NEITHER DIRECTV NOR ANY OF ITS LICENSORS EXPRESSLY MAKES OR PASSES ON TO YOU ANY WARRANTY OR REPRESENTATION ON BEHALF OF DIRECTV OR ITS LICENSORS WITH RESPECT TO THE SOFTWARE, INCLUDING BUT NOT LIMITED TO ANY WARRANTIES, EXPRESS OR IMPLIED, INCLUDING (BUT NOT LIMITED TO) ANY IMPLIED WARRANTIES OF MERCHANTABILITY, SATISFACTORY QUALITY, FITNESS FOR A PARTICULAR PURPOSE, TITLE OR NON-INFRINGEMENT OF THIRD PARTY RIGHTS.

IN NO EVENT WILL DIRECTV OR ITS LICENSORS BE LIABLE TO YOU WITH RESPECT TO THE SOFTWARE FOR ANY DIRECT, INDIRECT, CONSEQUENTIAL, SPECIAL, PUNITIVE OR INCIDENTAL DAMAGE (INCLUDING LOSS OF PROFITS, LOST SAVINGS, LOSS OF DATA OR THE COST OF PROCUREMENT OF SUBSTITUTE GOODS, TECHNOLOGY OR SERVICES) ARISING OUT OF THE USE OR THE INABILITY TO USE THE SOFTWARE, EVEN IF DIRECTV OR ITS LICENSORS HAVE BEEN ADVISED OF THE POSSIBILITY OF SUCH DAMAGES, OR FOR ANY CLAIM BY A THIRD PARTY. Some states or jurisdictions do not allow the exclusion or limitation of incidental, consequential or special damages, so the above limitations may not apply to you.

F. Third Party Beneficiaries

DIRECTV'S LICENSORS AND SUPPLIERS SHALL BE THIRD PARTY BENEFICIARIES OF THESE LICENSE TERMS, AS APPLICABLE.

YOUR USE OF THE RECEIVER CONSTITUTES YOUR ACKNOWLEDGEMENT THAT YOU HAVE READ THESE TERMS AND AGREE TO BE BOUND HEREBY.

G. Additional Information

Certain additional terms and information for the Software and certain third party software (including the text of licenses applicable to any free, open source and other similar software that may be included in the Software) may be found in the DIRECTV Customer Agreement, the DIRECTV website located at www.directv.com, and the GNU website located at www.gnu.org.

APPENDICES

● 1. SD AND HD RECEIVERS FRONT AND BACK PANELS	92
● STANDARD RECEIVER.....	92
● HD RECEIVER	96
● 2. ABOUT HIGH DEFINITION	100

Appendix 1: SD and HD Receivers Front and Back Panels

The layout of your DIRECTV® Receiver's front and back panels may vary slightly depending on model and manufacturer.

Standard Definition Receiver

FRONT PANEL:

The buttons on the front panel perform the same functions as the remote control. You can use the front panel buttons at any time, but they are there just in case you misplace your remote control or the batteries die.

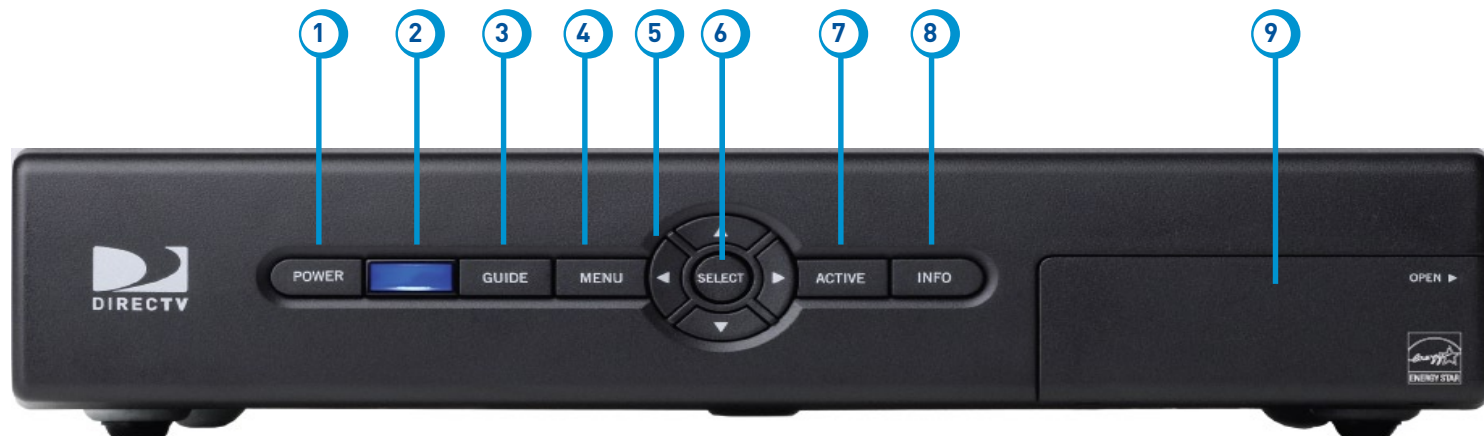

- 1. POWER** – Turns your DIRECTV® Receiver on or off. Your DIRECTV® Receiver still tunes and receives messages when powered off. The power light flashes when you press a key on the remote to let you know it has received the command.
- 2. REMOTE SENSOR** - The infrared sensor picks up commands from the remote control.
- 3. GUIDE** - Displays the on-screen program guide.
- 4. MENU** - Brings up the Main Menu to access settings and services.
- 5. ARROWS** – Move the on-screen highlight up, down, left or right.
- 6. SELECT** – Selects the item highlighted.
- 7. ACTIVE** – Displays the DIRECTV Interactive Home Page - local weather and more!
- 8. INFO** – Displays channel banner or info for a highlighted program or channel cell.
- 9. DOOR PANEL** – The access card slot, RESET button, receiver ID and model number are located behind the door panel.

STANDARD DEFINITION BACK PANEL:

Your equipment may not look exactly like the model illustrated.

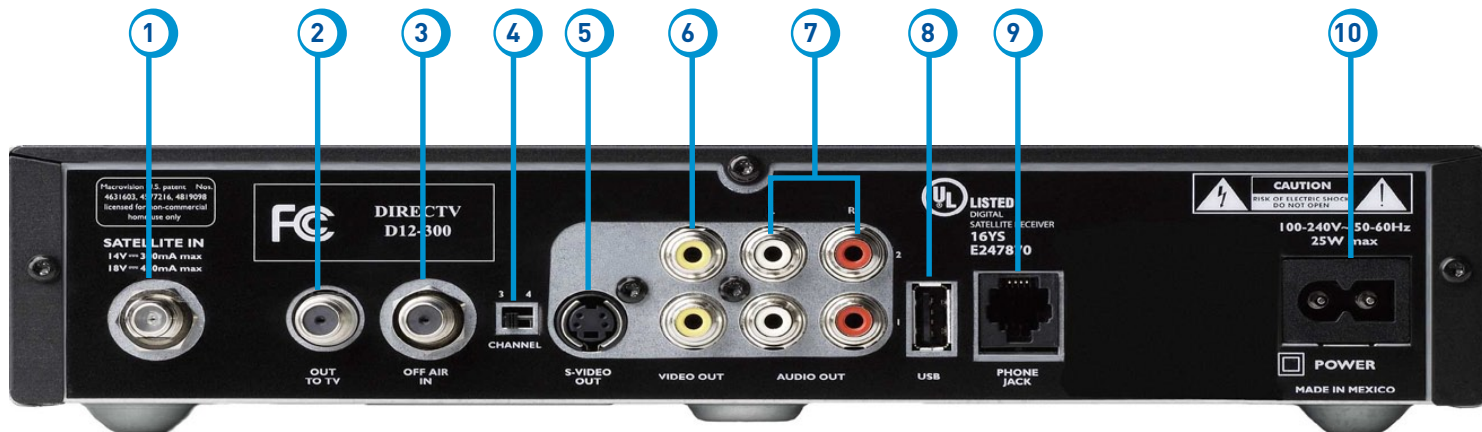

- 1. SATELLITE IN** – Use to connect the DIRECTV Receiver to the satellite dish antenna.
- 2. OUT TO TV** – Connects the DIRECTV Receiver to your TV or VCR using RF coaxial cable. This jack provides the most basic connection, carrying good sound and video quality.
- 3. OFF-AIR IN** – Connect a standard TV antenna or cable feed to the DIRECTV Receiver using this jack. You can then switch between the DIRECTV Receiver's signal and the TV/cable feed.
- 4. 3/4 CHANNEL SWITCH** – Allows users to choose the channel that is not used in your area (3 or 4) when the receiver is connected to TV using RF coaxial cable from the DIRECTV Receiver's OUT TO TV.
- 5. S-VIDEO** – Provides the best picture quality, better than VIDEO RCA-type or RF coaxial cable jacks. If your TV has an S-Video jack, use an S-Video jack, use it along with the audio jacks (S-Video only carries picture information, not sound) to connect to your TV.
- 6. VIDEO (YELLOW)** – Provides better picture quality than the OUT TO TV jack. Connect the second RCA-type composite VIDEO jack to another device, such as a VCR. You must also connect the AUDIO cables when using the VIDEO connection.
- 7. AUDIO (R-Red and L-White)** – Audio cables offer better sound quality than RF coaxial cables. You can connect a second set of audio cables to another component, such as a VCR or stereo.
- 8. USB PORT** – For future use.
- 9. PHONE** – Connects the DIRECTV Receiver to a telephone wall jack to enable Pay Per View purchasing and Caller ID (if your phone service package includes it).
- 10. POWER** – Connects the DIRECTV Receiver to an electrical outlet. We recommend you use a surge protector to safeguard your DIRECTV Receiver from power spikes.

HD Receiver

FRONT PANEL:

The buttons on the front panel perform the same functions as the remote control. You can use the front panel buttons at any time, but they are there just in case you misplace your remote control or the batteries die.

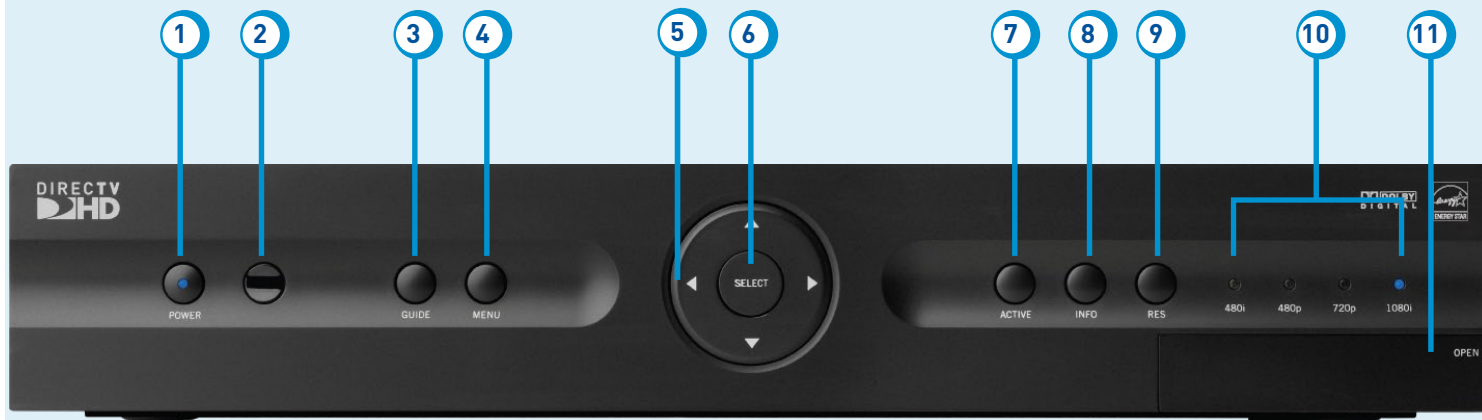

- 1. POWER** – Turns your DIRECTV® Receiver on or off. Your Receiver still tunes and receives messages when powered off. The power light flashes when you press a key on the remote to let you know it has received the command.
- 2. REMOTE SENSOR** – The infrared sensor picks up commands from the remote control.
- 3. GUIDE** – Displays the on-screen program guide.
- 4. MENU** - Brings up the Main Menu to access settings and services.
- 5. ARROWS** – Move the on-screen highlight up, down, left or right.
- 6. SELECT** – Selects the item highlighted.
- 7. ACTIVE** – Displays the DIRECTV Active™ Channel - local weather and more!
- 8. INFO** – Displays channel banner or info to a highlighted program or channel cell.
- 9. RESOLUTION** – The RESOLUTION key switches the output resolution of the HD receiver. Each time you press the key, it cycles to the next available resolution: 1080i, 720p, 480p and 480i.
- 10. RESOLUTION INDICATOR** – The adjacent lights indicate the current resolution setting.
- 11. DOOR PANEL** – The access card slot, RESET button, receiver ID and model number are located behind the door panel.

HD BACK PANEL:

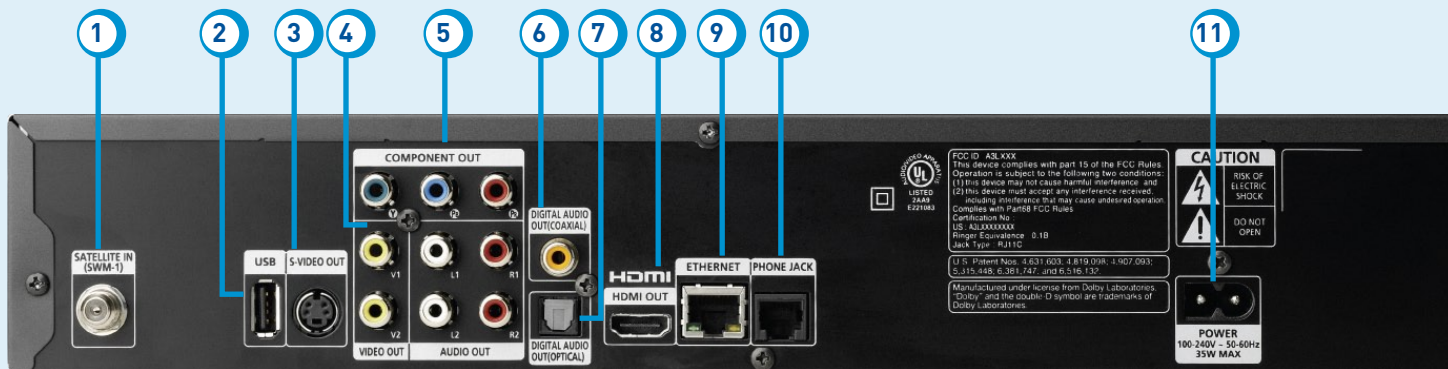

- 1. SATELLITE IN (SWM-1)** – Connect one line from your 5-LNB dish here. A Single Wire Multi-Switch (SWM) connection, if applicable, is made to this satellite in port.
- 2. USB** – For future use.
- 3. S-VIDEO OUT** – An SD output.
- 4. RCA-Audio/Video Jacks** – SD output. You can use the entire row of RCA connectors (yellow, white and red) to feed a VCR or DVD player/burner.
- 5. COMPONENT VIDEO OUT**– Use this block to connect up HD component video cables (green, blue, red) and use the white and red RCA connectors below it for analog audio out.
- 6. DIGITAL AUDIO OUT COAX** – Use this digital audio connection for sound.
- 7. DIGITAL AUDIO OUT OPTICAL** – Use this digital audio connection for sound.
- 8. HDMI** – Use this combination digital video and audio connector for the best HD picture quality.
- 9. ETHERNET** – For future use.
- 10. PHONE JACK** – Connect your phone line here to enable Pay Per View purchasing and Caller ID (if your phone service package includes it).
- 11. POWER** – Your receiver must be plugged in at all times to function properly.

 **This section applies to HD receivers only.**

Aspect Ratio

In addition to resolution and interlacing, a television picture is also defined by its aspect ratio—referring to the shape of the screen as defined by the ratio of the screen's width to its height.

For analog TV, the aspect ratio is 4 units wide by 3 units high (4:3). This is the familiar shape of conventional TVs—slightly wider than they are tall. SDTV and EDTV pictures can be either 4:3 or 16:9. For HDTV broadcasts, the aspect ratio is 16:9—nearly twice as wide as it is tall. This is, not coincidentally, more like the shape of movies shown in theaters, which makes HD an ideal format for viewing movies on TV. You will be able to see much of what is captured on film, but lost on an SDTV display.

Screen Formats

What if you're watching a nearly square-shaped 4:3 broadcast on a 16:9 TV, or vice versa? The DIRECTV HD Receiver lets you choose from a variety of screen formats to deal with those scenarios. You can set up your preferences for format during Guided Setup and change them at any time.

See the next pages for your options.

Options for Changing Video Output

In order to optimize the display of programs on your television, you may occasionally need to change the resolution and/or screen format. There are two keys that can be used to make changes: the FORMAT key on the remote control and the RES (Resolution) key on the front panel of the DIRECTV HD Receiver.

FORMAT key on Your Remote

Pressing this key will cycle the resolutions that you've indicated in System Setup as being supported by your TV. In addition, it will cycle the three available screen formats in conjunction with each individual resolution. Available screen formats are based on the TV Aspect Ratio you set in System Setup. With each press, an on-screen message will let you know what the current resolution/format setting is. For example, if you indicated that your TV supports only 1080i, 480i and 480p and it is a 16:9 television, and Native is turned off*, the cycle of settings for the FORMAT key are as follows:

1st press: 480i/Stretch
2nd press: 480i/Letter box
3rd press: 480i/Crop
4th press: 480p/Stretch
5th press: 480p/Letter box

6th press: 480p/Crop
7th press: 1080i/Stretch
8th press: 1080i/Letter box
9th press: 1080i/Crop
10th press: repeat cycle

Note:

* In Native mode, the receiver automatically adjusts resolutions to match the resolution of individual TV programs as they are tuned.

If your TV supports all formats (1080i, 720p, 480i and 480p), then your cycle would also include 720p. If Native is turned on, the FORMAT key cycles through Stretch, Letter and Crop for the current TV program's native resolution. The FORMAT key allows you to easily cycle all resolution and format settings with a single key until the picture displays the way you like it. Navigating menus to modify settings is not necessary.

If pressing this key causes a loss of video and audio, continue to press it until the picture returns. (Wait a second between presses to allow the Receiver to change the resolution.) This can happen if your settings include a resolution that your TV doesn't support. To correct this, you'll need to change your resolution setting: Press MENU, select Parental, Fav's & Settings, then System Setup, then HDTV in the left side menu. Press SELECT on the Resolution tab and mark or unmark the TV Resolutions to display the resolutions supported by your television.

Resolution (RES) Key on Receiver Front Panel

This key is used to through cycle all available resolutions on your DIRECTV HD Receiver. It does not through cycle format settings. If video and audio are not appearing, it may be because the current resolution setting is not supported by your television. By pressing this key, you can check all available resolutions to see if that solves the problem. The lights next to the RES key on the front panel will light below the resolution to which the receiver is set; they will change with each key press.

Supported Resolutions

The following table shows the resolutions that can be output from each type of connection:

Output Connection	Available Resolutions
HDMI	1080i, 720p, 480i, 480p
Component Video (YPbPr)	1080i, 720p, 480i, 480p
S-Video	480i
Video (RCA Type/Yellow)	480i

Note:

720p and 1080i are HD formats. 480i and 480p are not.
S-Video and RCA outputs display all resolutions as 480i.

Wide-Screen vs. Standard Formats

4:3 TVs Showing 16:9 programs

For a standard 4:3 TV showing a wide screen program, the program is too wide to fit on the screen. To alleviate this, choose:

- Letterbox

With this format, the 16:9 image is shrunk until the entire width of the program fits on your TV. Since the aspect ratio of the program is maintained, the image is no longer tall enough to fill your screen, so gray or black bars are seen at the top and bottom of the screen. To change the bar color, press MENU, select Parental, Fav's & Settings, then System Setup, then select the Display menu. Highlight the Preferences tab and press SELECT, then set Bar Color option to the desired color. See your TV owner manual for information on the best color for your set.

- Stretch

In the Stretch setting, instead of adding bars to the top and bottom, the 16:9 program image is stretched vertically until it's tall enough to fill the screen. Your entire screen will be full, but the program images are stretched to compensate.

- Crop

This format crops (cuts off) the left and right portions of the 16:9 frame so it fits the 4:3 screen.

If your display is a 4:3 format TV or monitor, your format options include these:

For 4:3 program signals:



Fills TV Screen

For 16:9 program signals:



Letterbox



Stretch



Crop

16:9 TVs Showing 4:3 programs

For a wide screen 16:9 TV showing a standard 4:3 TV program, the program is too tall to fit the screen. Your choices here include:

- Pillar Box

Here the 4:3 image is shrunk until the entire height of the program fits on your TV. Since the aspect ratio is maintained, the image is no longer wide enough to fill the screen, so gray or black bars are seen at the left and right edges. To change the bar color, press MENU, select Parental, Fav's & Settings, then System Setup, then HDTV, then select the desired bar color option under the Video Tab.

- Stretch

In this setting, instead of adding bars to the sides, the 4:3 program image is stretched horizontally until it's wide enough to fill the screen. Your entire screen will be full, but the images are a little stretched to compensate.

- Crop

This format crops (cuts off) the top and bottom of a 4:3 frame, keeping the 4:3 ratio intact.

If your display is a 16:9 format TV or monitor, your format options include these:

For 4:3 program signals:



Pillar Box



Stretch



Crop

For 16:9 program signals:



Fills TV Screen

INDEX

A

Access Card - 56, 93, 97
Activation - 62
Audio Connections - 59
Audio Options - 29, 51
Audio sync - 73
Autotune - 30, 36, inside back cover
Auxiliary Equipment - 58

B

Back Panel - 94, 98
Batteries - 12

C

Cables - 58-59
Caller ID -30,39, 95
Caller ID Notification - 39
Category Sort- 25
Channel Banner - 17
Channel Blocks - 43
Clock - 53
Closed Captioning - 28, 53
Component Video Output - 59-61

Connections - 59-61
Customer Care - 20, 30, 40
Customize Guide see Favorite Chan List

D

Date & Time - 25
Defaults - 56, 63
Deleting - 21, 31, 36, 37, 38, 39
Destination Buttons - 13
Digital Audio - 51, 59-61, 99
DIRECTV Mode - 12
DIRECTV Protection Plan - 82-83
Display - 52-53
Dolby® Digital - 51
Download - 18, 38, 68, 88
DVD player/burner - 58-61

E

Episodes - inside back cover
Error Messages - 67
Ethernet - 99
Exit - 13, back cover

F

FAQs - 40
Favorite Channels List - 41, 47
FCC Customer Information - 84-87
Filtering the Guide - 24
Folders - 31, 38, 40, inside back cover
Front Panel - 66, 92, 96

G

Game Lounge - 19
Guide - 14
 banner - 16
 channel programs list - 27
 customizing - 26
 favorite channels - 26
 filtering - 24
 jump to a date and time - 25
 options - 25
 sorting programs - 25
Guided Setup - 62

H

HD
 about - Appendix 2
 channels - 15, 24, 53
 filtering - 24, 53
HDMI - 59, 60, 99, 102
HDTV - 54-55, Appendix 2
Help - 30, 40
Help Topics - 40
History - 37
Home Page Interactive - 13, 93

I

Icons - 17, 36, 38, inside back cover
Installation - 57-63
Interactive Channels - 18, 19

K

Keyword Search - 34

L

Language - 17, 29, 51, 62
Live TV - 14-20
 options - 28, 29
Local Channels - 14
Lock (Parental Controls) - 45

M

Main Menu - 21, 30-56
Manage Autotunes - 30, 36-37
Manual Autotune - 37
Messages - 30, 38
Mini-guide - 16
Mode Switch - 12, 62, 69, back cover
Model Number - 84, 93, 97
Movie Ratings - 42
Music - 3
Mute- back cover

N

Navigation Buttons - 13
Network - 48
News Mix Channels - 18

O

Other Ratings - 43

P

Parental Controls - 41-46
 channel blocks - 43
 hours (viewing) - 44
 locking - 45
 passcode - 41, 45-46
 ratings - 42
 spending - 44
 unlocking - 45-46
Passcode - 41, 45-46
Pay Per View - 3, 20
Phone Connection - 58
Power - 12, 69, 93, 95, 97, 99, back cover

Power Surge - 9, 82
Press and Hold Buttons - back cover
Previous Channels - 28
Program Details - 14, 17
Program Guide (see Guide)
Progress Bar - 68
Purchases - 37

R

Ratings - 42
RCA connectors - 59-61, 95, 99
Rear Panel - 94-95, 98-99
Recent Searches - 35
Remote Control - back cover
 buttons - 12-13
 modes - 12
 problems - 75
 programming - 63
Repair - 78-80, 82, 87
Reset
 passcode - 46
 receiver - 56, 63, 66, 93, 97
Resolution - 54-55, 97, 100-102

Resolution Indicator - 96, 97
Restart - 56
RF Remote - 50

S

Satellite Data Acquisition - 68
Satellite Signal Strength - 49
Searching for a Show - 31
 by channel - 33
 by title - 31
 by keyword - 34
 by person - 32
Series - 36
Settings - 41, 48-55
Setup (see System Setup)
Shortcut Buttons - 13
Shortcut Hints - 13, 17
Skip - back cover
Software - 38, 67, 79, 88-90
Software License - 88-90
Sort - 25, 27
Sound Effects - 51
Spending Limits - 44

Sports Mix Channels - 18
Surround Sound - 49, 51, 58, 61
System Info - 48
System Messages - 17, 30
System Settings - 48-55
System Setup - 48-55
System Software Updates - 67
System Test - 76
S-video - 59, 61, 95, 99, 102

T

Temporarily Unlock - 45
To Do List - 13, 36, back cover
Troubleshooting - 66-76
TV Problems - 68-74
TV Ratings - 42

U

Unsubscribed Channels - 15

V

VCR - 58-61, 95, 99

Video - 54, 59, 100

W

Warranty - 78-80

Watching live TV - 14-21, 28

ACTIVATION OF PROGRAMMING SUBJECT TO CREDIT APPROVAL. PREPAYMENT MAY BE REQUIRED. CREDIT CARD REQUIRED (except in MA and PA). Programming subject to change. DIRECTV Services not available outside the U.S. DIRECTV programming is available separately and independently of DIRECTV System hardware. A valid programming subscription is required to operate DIRECTV System hardware. Activate your DIRECTV programming today at 1-800-DIRECTV (1-800-347-3288). ©2008 DIRECTV, Inc., DIRECTV and the Cyclone Design logo, DIRECTV Active, DIRECTV INTERACTIVE and Game Lounge are trademarks of DIRECTV, Inc.

This product incorporates copyright protection technology that is protected by U.S. patents and other intellectual property rights. Use of this copyright protection technology must be authorized by Macrovision Corporation, and is intended for home and other limited viewing uses only unless otherwise authorized by Macrovision. Reverse engineering or disassembly is prohibited.

Due to restrictions imposed by copyright holders, certain programming may include content protection measures that may restrict viewing in high definition and/or recording with certain consumer electronics equipment attached to the receiver. Please contact the manufacturer of such equipment for additional information.

THIS PRODUCT IS LICENSED UNDER THE AVC PATENT PORTFOLIO LICENSE FOR THE PERSONAL AND NON-COMMERCIAL USE OF A CONSUMER TO (i) ENCODE VIDEO IN COMPLIANCE WITH THE AVC STANDARD (“AVC VIDEO”) AND/OR (ii) DECODE AVC VIDEO THAT WAS ENCODED BY A CONSUMER ENGAGED IN A PERSONAL AND NON-COMMERCIAL ACTIVITY AND/OR WAS OBTAINED FROM A VIDEO PROVIDER LICENSED TO PROVIDE AVC VIDEO. NO LICENSE IS GRANTED OR SHALL BE IMPLIED FOR ANY OTHER USE. ADDITIONAL INFORMATION MAY BE OBTAINED FROM MPEG LA, L.L.C. SEE [HTTP://WWW.MPEGLA.COM](http://www.mpegla.com)

















Standard and HD Receivers Web Version - Version 1.0 - 121608



This DIRECTV Set Top Box meets
ENERGY STAR guidelines.*

*May not apply to
older models.

Icon Reference

Arrow Icons		Indicate that a show's start or end time is earlier or later than is visible in the Guide program cell.
		LEFT and RIGHT arrows on the remote offer special functionality.
		Objects are scrollable above or below the visible window
		UP and DOWN arrows on the receiver front panel offer special functionality.
Other Icons		Indicates a program is set to Autotune
		Denotes one or more alternate audio tracks available for a program.
		Denotes that no alternate audio tracks available.
		Indicates one or more new messages are in the Inbox.
		Indicates no new messages are in the Inbox.
		Shows that Parental Control limits are currently "locked."
		Shows that limits are temporarily unlocked.
		Shows that there are no current limits imposed.
		Indicates a rating level or channel that is blocked via Parental Controls.
		Indicates a Pay Per View program is available as an All Day Ticket replay.
		Indicates program shown in letterbox format.
		Denotes an error condition has occurred.
		Episodes in a series or similar items are grouped in a folder.

MODE SWITCH

Changes remote to control other equipment, for example a DVD Player.

DIRECTV® & TV POWER ON

Turns your DIRECTV® Receiver and TV on and off together.

TV INPUT Changes the "source" - the piece of equipment whose signal is displayed on your TV.

HDP-FORMAT Cycles through screen formats (crop, stretch, pillar box, letter box) and resolutions.

STOP* Stops Recorded Video

REPLAY* Jumps back 6 seconds. Hold down to jump back to the beginning.

REWIND* Press up to four times to rewind at increasing speed.

PAUSE* Pauses current video.

ACTIVE Display the DIRECTV Active Channel-local weather and more!

GUIDE Display the on-screen program guide.

SELECT Selects any highlighted item.

BACK Takes you back one navigation screen.

MENU Display a compact menu of settings and services.

RED In Guide, jumps 12 hours back; other functions vary - look for hint on-screen.

GREEN In Guide, jumps 12 hours forward; other functions vary - look for hint on-screen.

VOLUME Raises or lowers volume.

MUTE Toggles sound volume on/off.

NUMBERS & DASH

Tune to a channel directly; also input numbers when needed in on-screen menus.



POWER Turn your DIRECTV® Receiver or other equipment on and off separately, as selected with MODE switch.

SKIP* Jumps ahead 30 seconds. Hold down to jump forward to the end.

PLAY* Play current video; press and hold for slow motion.

FFWD* Press up to four times to fast forward at increasing speeds.

RECORD* In Live TV, records current program; in the Guide, sets one-touch record for highlighted program.

LIST Displays the To Do list.

EXIT Exits any menu and returns to last channel viewed.

ARROWS Move highlight to items in whatever direction needed.

INFO Displays info for a highlighted or full screen program.

BLUE In live TV, displays the Mini guide; other functions vary - look for on-screen hints.

YELLOW In full screen TV, shows live TV options; other functions vary - look for on-screen hints.

CHAN/PAGE In live TV, changes channel up or down; in a menu, such as the guide, scrolls page up and down.

PREV Tunes to previous channel viewed.

ENTER Activates channel number entries quickly.

Keys in orange text can be programmed to function with your VCR, DVD player or other stand alone equipment.

* These descriptions apply to DIRECTV Digital Video Recorders. Other equipment may behave differently.